



SDS2000X Series Super Phosphor Oscilloscope

Quick Start



Copyright Information

SIGLENT TECHNOLOGIES CO., LTD. All Rights Reserved.

Declaration

SIGLENT products are protected by patent law in and outside of P.R.C.

SIGLENT reserves the right to modify or change parts of or all the specifications or pricing policies at company's sole decision.

Information in this publication replaces all previously corresponding material.

Any way of copying, extracting or translating the contents of this manual is not allowed without the permission of **SIGLENT**.

Note: SIGLENT is the registered trademark of SIGLENT TECHNOLOGIES CO., LTD.

General Safety Summary

Carefully read the following safety precautions to avoid any personal injury or damage to the instrument and any products connected to it. To avoid potential hazards, please use the instrument as specified.

Use Proper Power Cord

Only the power cord designed for the instrument and authorized by local country could be used.

Ground the Instrument

The instrument is grounded through the protective earth conductor of the power cord. To avoid electric shock, please make sure the instrument is grounded correctly before connecting its input or output terminals.

Connect the Signal Wire Correctly

The potential of the signal wire ground is equal to the earth, so do not connect the signal wire to a high voltage.

Look Over All Terminals' Ratings

To avoid fire or electric shock, please look over all ratings and sign instruction of the instrument. Before connecting the instrument, please read the manual carefully to gain more information about the ratings.

Use Proper Overvoltage Protection

Make sure that no overvoltage (such as that caused by a thunderstorm) can reach the product, or else the operator might expose to danger of electrical shock.

Electrostatic Prevention

Operate in an electrostatic discharge protective area environment to avoid damages induced by static discharge. Always ground both the internal and external conductors of the cable to release static before connecting.

Keep Well Ventilation

Inadequate ventilation may cause increasing of temperature, which may eventually damage the instrument. So keep well ventilation and inspect the intake and fan regularly.

Avoid Circuit or Components Exposed

Do not touch exposed contacts or components when the power is on.

Use Only the Specified Fuse

Do Not Operate Without Covers

Do not operate the instrument with covers or panels removed.

Safety Terms and Symbols

Terms on the product. These terms may appear on the product:

- DANGER** Indicates direct injuries or hazards that may happen.
WARNING Indicates potential injuries or hazards that may happen.
CAUTION Indicates potential damages to the instrument or other property that may happen.

Symbols on the product. These symbols may appear on the product:



General Care and Cleaning

Care

Do not store or leave the instrument in direct sunshine for long periods of time.

Notice:

To avoid damages to the instrument or probe, please do not leave them in fog, liquid, or solvent.

Cleaning

Please perform the following steps to clean the instrument and probe regularly according to its operating conditions.

1. Disconnect the instrument from all power sources, and then clean it with a soft wet cloth.
2. Clean the loose dust on the outside of the instrument and probe with a soft cloth. When cleaning the LCD, take care to avoid scratching it.

Notice:

To avoid damages to the surface of the instrument and probe, please do not use any corrosive liquid or chemical cleanser.

Make sure that the instrument is completely dry before restarting it to avoid short circuits or personal injuries.

Contents

Copyright Information.....	I
General Safety Summary.....	II
Quick start.....	2
The Front Panel	6
The Rear Panel.....	7
Front Panel Overview.....	8
User Interface.....	17
Using Security Lock.....	19
Troubleshooting.....	20
Contact us.....	22



Quick start

General Inspection

1. Inspect the shipping container

Keep the damaged shipping container or cushioning material until the contents of the shipment have been completely checked and the instrument has passed both electrical and mechanical tests.

The consigner or carrier will be responsible for damages to the instrument resulting from shipment. SIGLENT would not provide free maintenance or replacement if the instrument has been damaged in shipment.

2. Inspect the instrument

If there are instruments found damaged, defective or failure in electrical and mechanical tests, please contact SIGLENT.

3. Check the accessories

Please check the accessories according to the packing list. If the accessories are incomplete or damaged, please contact your SIGLENT sales representative.

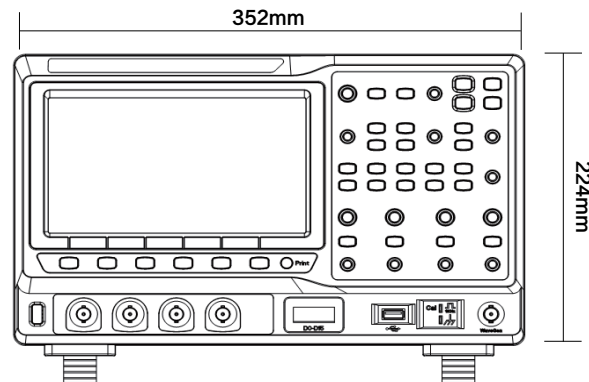

Figure 1 Front View

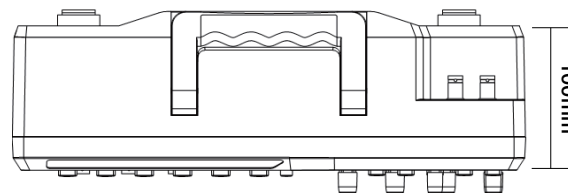
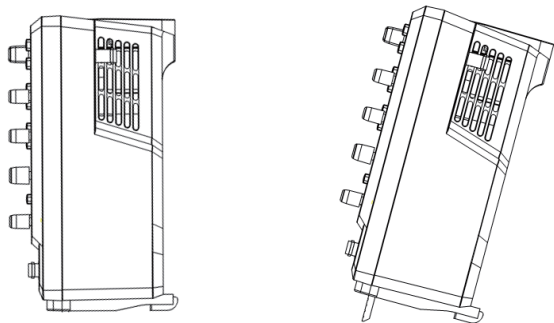

Figure 2 Top View

Quick start

Adjust the Supporting Legs

Adjust the supporting legs properly to use them as stands to tilt the oscilloscope upwards for stable placement as well as easier operation and observation of the instrument.



Connect to AC Power Supply

The oscilloscope will accept a 100~240V, 50/60Hz or 100~120V, 400Hz AC power supply. Please use the power cord provided with the accessories to connect the instrument to the power source as shown in the figure below.

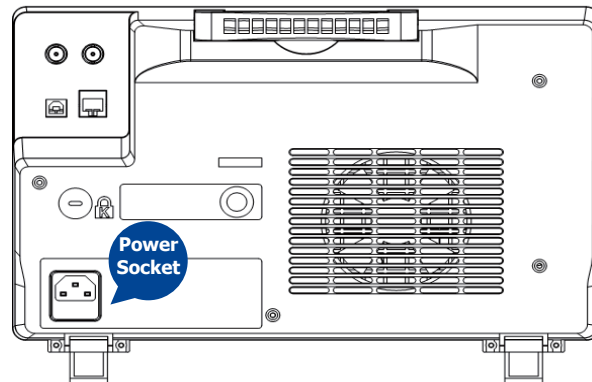

If at any time the fuse requires replacement, please replace only with a fuse of the same rating as the original. If there are questions, please contact Siglent directly.

Quick start

Power-on Inspection



After plugging in the oscilloscope, turn on the power switch at the lower left corner on the front panel. During the start-up process, the instrument performs a series of self-test items and the internal relays can be heard in operation. After the self-test, the User Interface displays immediately.

Connect the Probe

SIGLENT provides passive probes for the SDS2000X series oscilloscope. Please refer to corresponding Probe User Manual for detailed technical information.

1. Connect the BNC terminal of the probe to one of the channel BNC connectors on the front panel.
2. Connect the probe tip to the circuit point under test and the ground alligator clip of the probe to the ground terminal of the circuit.

Functional Inspection

1. Press  to reset the oscilloscope to its factory default setup.
2. Connect the ground alligator clip of the probe to the Ground Terminal on the front panel.
3. Use the probe to connect the CH1 Input Terminal and the Compensation Signal Output Terminal on the front panel.
4. Press .
5. Observe the waveform on the screen. In normal condition, the display should be a square waveform as shown in the photo to the right.
6. Test the other channels in the same method. If the actual square waveforms does not match that in the photo shown, please perform "Probe Compensation".

Note: To avoid electric shock when using the probe, first please make certain that the insulated wire of the probe is in good condition, and do not touch the metallic part of the probe when it is connected to a high voltage.

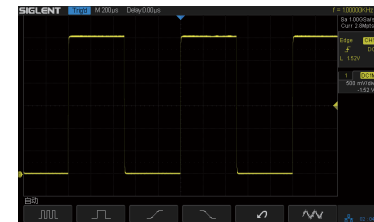
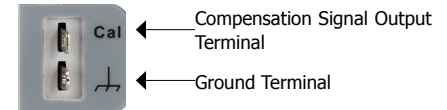

Quick start

Probe Compensation

All oscilloscope probes should be properly compensated before their first use with the oscilloscope. Non-compensated or inadequate compensated probe may cause inaccurate measurement. The following steps illustrate the proper probe compensation procedure.

1. Perform step 1, 2, 3 and 4 of "Functional Inspection".
2. Check the displayed waveforms and compare them with the following figure.

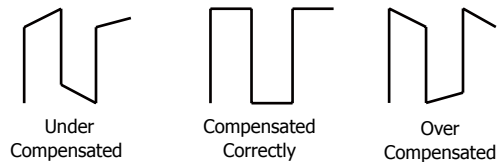

3. Use a nonmetallic flat-head screwdriver to adjust the low-frequency compensation adjustment hole on the probe until the waveform matches the "Compensated Correctly" waveform above.

The Front Panel



- 1.Horizontal Control
- 2.Auto Setup
- 3.Run/Stop
- 4.Default
- 5.Clear Sweeps
- 6.Universal Knob

- 7.Trigger Control
- 8.Decode Control
- 9.Digital Channel Control
- 10.Math
- 11.Reference
- 12.Math/Ref Vertical Control

- 13.Function Menus
- 14.WaveGen Control
- 15.Channel Vertical Control
- 16.WaveGen Output
- 17.Probe Compensation/
Ground Terminal

- 18.USB Host
- 19.Digital Inputs
- 20.Analog Inputs
- 21.Print
- 22.Function Menu Softkeys
- 23.Power On/Off

The Rear Panel

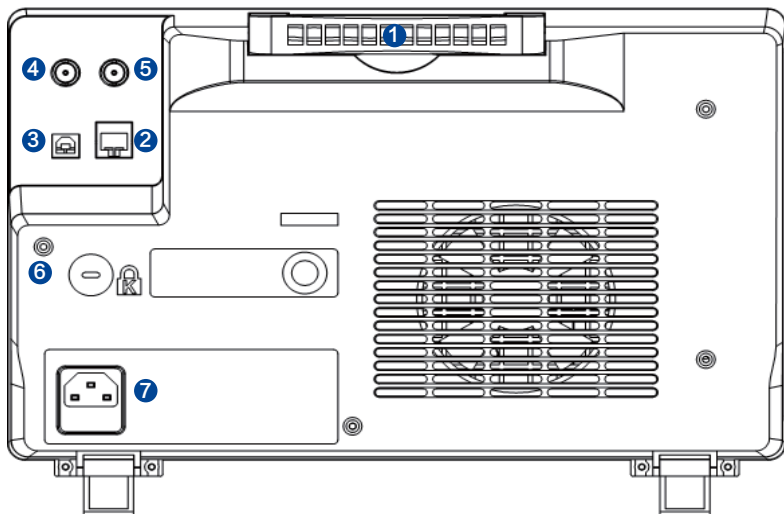

1. Handle

Pull up the handle vertically for easy carrying; press it down if you do not need the handle.

2. LAN Interface

The instrument can be connected to a user-network via this interface to perform remote control.

3. USB Device

The SDS2000X-series support SCPI remote control commands. User can control the oscilloscope through this interface.

4. Pass/Fail or Trig Out Output

This connector outputs either a Pass/Fail pulse when using this mode of operation or it can be used to output a pulse that corresponds to each oscilloscope trigger operation.

5. External Trigger Connector

6. Safety Lock Hole

This hole is designed to accommodate a Kensington style of lock (user-supplied).

7. AC Power Socket

The standard power supply for the instrument is 100~240V, 50/60Hz or 100~120V, 400Hz. Please use the power cord provided with the instrument to connect it to AC power.

Front Panel Overview

Horizontal Control

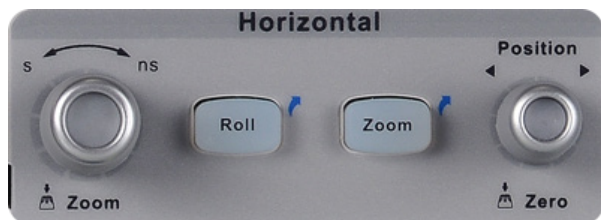

Roll Quickly enter into the horizontal Roll mode.
The timebase range is from 50 ms/div to 50 s/div.

Horizontal POSITION  Sets the horizontal location of the trigger event on the display. The waveform will move left or right when you turn the knob. Meanwhile, the Delay value will increase or decrease as the waveform moves. Press down the knob to reset the trigger delay to zero.

Horizontal Time Base  Sets the timebase (horizontal sweep) speed. Turn it clockwise or counterclockwise to reduce or increase the timebase. The displayed waveform will be expanded or compressed when the timebase changes. Press down the knob to enter into the Zoom mode.

Trigger Control

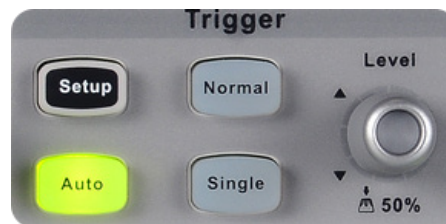

Setup Press the button to open trigger menu. This oscilloscope provides various trigger types: Edge, Slope, Pulse, Video, Window, Interval, Drop Out, Runt, Pattern and Serial Bus (I2C/SPI/UART/RS232/CAN/LIN).

Video, Interval, Runt, Pattern, and Serial Bus triggering are explained below.

HDTV Video Trigger

SDS2000X supports analog video signal (NTSC/PAL) trigger and HDTV signal trigger. In video trigger, you can select custom to set any line and field.

Interval Trigger

The oscilloscope is triggered when the input signal passes through the set trigger level on its rising edge (or falling edge) and then the trigger level again on the next rising edge (or falling edge) and satisfies the set time limit ($<$, $>$, $[-, -]$, $[-, -]$ $[-, -]$ selected).

In the screen shot below the time interval between two consecutive rising edges is set to satisfy the limit range ($[-, -]$).

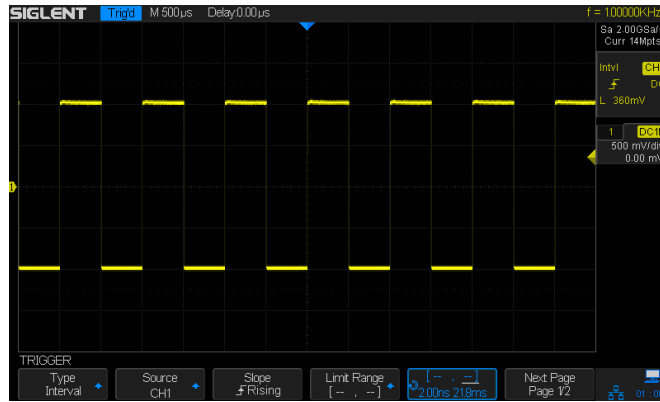

Runt Trigger

Runt trigger conditions can include positive and negative runts. This mode is used to trigger the oscilloscope when pulses pass through one trigger level but fail to pass through the other level as shown in the figure below.

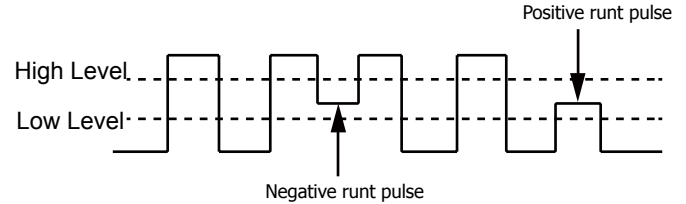

In the figure below, the trigger signal are positive runt pulse.

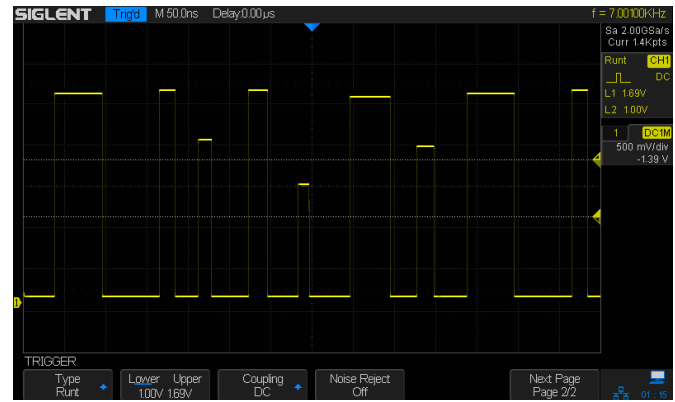

Pattern Trigger

Identifies a trigger condition by looking for a specified pattern. This pattern is a logical combination (AND/OR/NAND/NOR) of the two channels. Each channel can be set a value among High, Low or Invalid.

In the figure below, the selected logic is "AND", both Channel 1 and Channel 2 are set to "High."

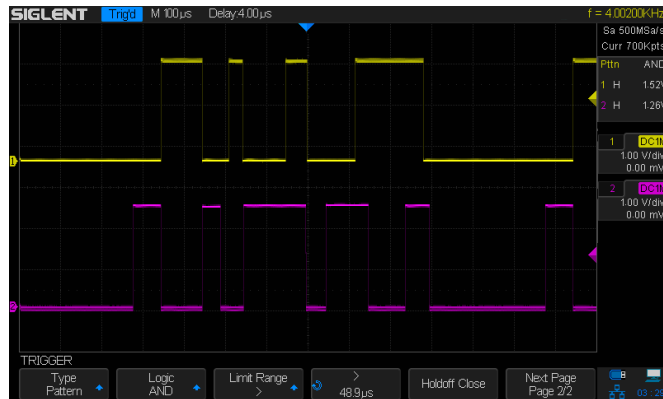

I2C Trigger

After setting the Serial 1 or Serial 2 trigger to I2C in the Trigger menu, use the universal knob to set the trigger to a start or stop condition, restart, no ack, EEPROM, or on the read/write frame with a specific address and data value. When using I2C trigger settings it is essential to set the correct source channel in the previous decode menu.

In the figure below, the trigger condition is set to "Start".

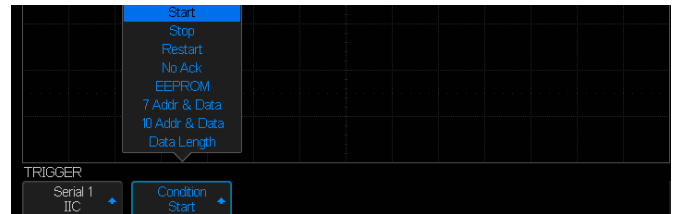

SPI Trigger

After setting the serial trigger to SPI type in trigger menu, you can select to trigger on MISO data or MOSI data. The data length are variable to set from 4 to 96.

UART/RS232 Trigger

After setting the serial trigger to UART/RS232 type in trigger menu, you can select to trigger on start, stop, checksum error or data. The data width are variable to set from 5 to 8bits.

CAN Trigger

After setting the serial trigger to CAN type in trigger menu, you can select to trigger on start, remote, ID, ID+DATA or Error of CAN-H or CAN-L signal.

LIN Trigger

After setting the serial trigger to LIN type in trigger menu, you can select to trigger on Start, ID, ID+DATA or Data Error.

Notes: For more trigger types and corresponding operation information, please refer to the trigger chapter of SDS2000X User Manual.



Press the button to set to Auto trigger mode.



Press the button to set to Normal trigger mode.



Press the button to set to Single trigger mode.



Level Set the trigger level. Turn it clockwise or counterclockwise to make the level move up or down. In addition, the trigger level value is displayed in the upper right portion of the display. Press the knob to quickly reset the trigger level to the 50% of waveform.

Vertical Control

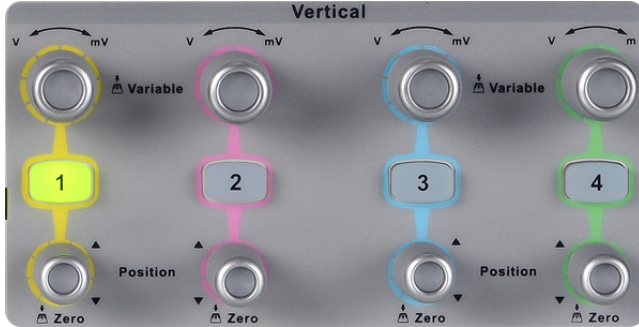

1 Analog input channels. The four channels are marked by different colors which are also used to mark both the waveforms on the screen and the channel input connectors.

Press channel button to open the corresponding channel and press again to turn it off.

Vertical POSITION  Set the vertical offset of current waveform. Turn clockwise to increase the offset while turn counterclockwise to decrease the offset.

When changing the offset, the waveform will move up and down and the offset message at the lower part of the screen will change accordingly. Press down the knob to quickly reset the offset to zero.



Vertical Scale: Sets the vertical scale of current waveform. Turn clockwise to decrease the scale value and while turn counterclockwise to increase it. During the modification, the 'amplitude' of the waveform will enlarge or reduce and the scale message at the right side of the screen will also change. Press down the knob to quickly switch the vertical scale adjustment modes between "Coarse" and "Fine".



Decode Press this button to open decode menu. Decode is an optional function. SDS2000X supports two serial buses including 1 and 2 for analog signal decoding. The protocols includes I2C, SPI, UART/RS232, CAN and LIN.

Decoding of I2C signal with a 7 bit address is shown in the following photo.

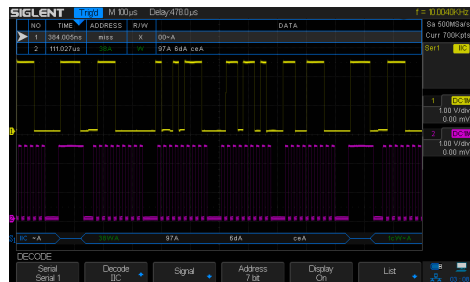

Press the button to open the digital channel function menu (Optional function). The SDS2000X support 16 digital channels.



Press the button to open the Math operation menu in order to select functions including add, subtract, multiply, divide, FFT, integral, differential, and square root.



Press the button to enable the stored Reference waveform function. The reference waveform can be used in comparisons to the current waveform. The SDS2000X supports saving up to 4 reference waveforms.

Vertical POSITION



Set the vertical offset of Math or Ref waveform. Turn clockwise to increase the offset or turn counterclockwise to decrease the offset. During the modification, the waveform will move up and down and the offset message at the lower part of the screen will change along. Press down the knob to quickly reset the offset to zero.

Vertical Scale



Set the vertical scale of Math or Ref waveform. Turn clockwise to decrease the scale or turn counterclockwise to increase it. During the modification, the 'amplitude' of the waveform will increase or decrease and the scale value displayed on the right side of the screen will change accordingly. In addition, the knob can be used to change a digital channel.

Run Control



Auto Setup

Press the button to enable the waveform auto setup function. The oscilloscope will automatically adjust the horizontal time base, vertical scale and trigger mode according to the input signal to provide a triggered stable display.

Run/Stop

Press the button to set the state of the instrument to "RUN" or "STOP". In the "RUN" state, the button glows yellow; In "STOP" state, the button glows red.

Default

Press the button to reset the oscilloscope to its default setup. The default voltage scale and timebase scale are respectively 1V/div and 1 μ s/div.

Clear Sweeps

This button is a shortcut key for clear function. When measurement statistics are being displayed, press this button to clear the count and begin a new statistical count. When the screen persistence feature is turned on, press this button to clear the persistence.

Universal Knob



Adjust Waveform Intensity/Grid Brightness/Transparency

In non-menu-operation mode, (menu is hidden), turn this knob to adjust waveform intensity (0% ~ 100%). Turn clockwise to increase the brightness and counterclockwise to reduce. You can also press  → **Intensity** and use the knob to do adjusting. To adjust grid brightness (0% ~ 100%) or transparency (20% ~ 80%), please operate in the same way as waveform intensity.

Universal Knob

In menu operation – when the light below the knob is lit – this knob can be used to select between submenus under the current menu. Press the knob to select the current submenu. In addition, it can be used to modify parameters and to input a file name.

Function Menus

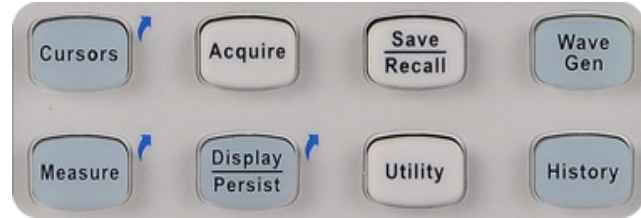

 **Cursors** Press the button to open the cursor function. It provides manual and tracking cursor modes.

 **Display Persist** Press the button to enter the display menu and quickly enable the persist function. User can set the grid, Intensity, brightness, transparency.

 **History** Press this button to enter the history mode. History mode can record up to 80,000 frames. If the Sequence function is enabled, only the selected frames are recorded (up to 80,000).

Utility

Press the button to enter the utility menu to set system functions or parameters, such as I/O set, sound, and screen language. In addition, some advanced functions (such as Pass/Fail, Self Cal, install option function and Update) are also supported.

Measure

Press the button to enter the measurement setting menu. The user can set measurement type(s), statistics and gating. Up to five parameters can be selected.

When using the Statistics function, the Current value, Mean, Min, Max, Std-Dev and Count are shown on the screen.

Select All Measure to display all measured parameters for the selected channel.

Acquire

Press the button to enter the sampling menu. You can set the acquisition mode (Normal/Peak-Detect/Average/Eres), interpolation mode (Sinx/x or linear) and memory depth. The XY mode can be selected here as well as the Sequence function.

Save
Recall

Press the button to enter the file save and recall function menu. The storable file types includes Setups, Waveforms, Picture and References.

Wave
Gen

Press the button to open the WaveGen menu. The SDS2000X provides a built-in function generator (optional). 11 types of Waveforms including Sine, Square, Ramp, Pulse, DC, Noise, Cardiac, Gaus Pulse, ExpRise, ExpFall and Arb are supported.

The max output frequency is 25MHz (Sine Wave). In addition, the user can download and output four waveforms using Siglent's EasyWave software.

User Interface

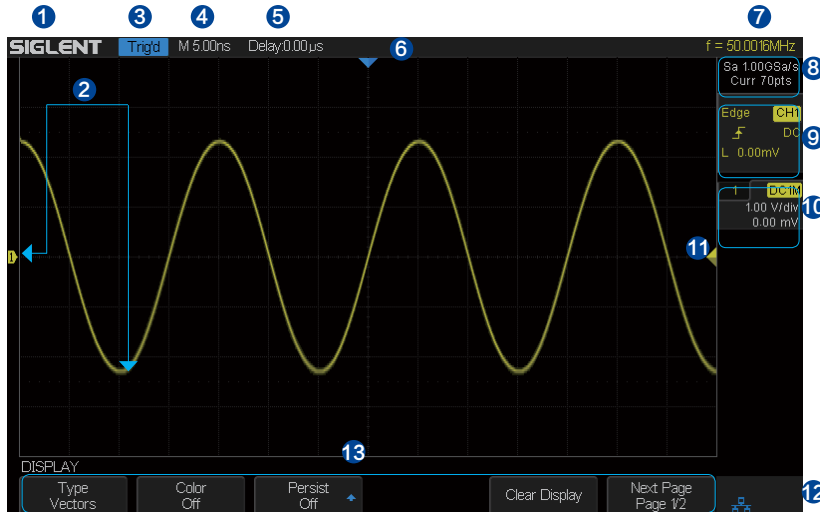

1. Product Logo

SIGLENT is the registered trademark of our company.

2. Channel Label/Waveform

Different channels are marked by different colors and the color of the waveform matches with the color of the channel.

3. Working state

Available states include Arm, Ready, Trig'd, Stop, Auto.

4. Horizontal Time Base

Represents the time of each grid on the horizontal axis of the screen. Turning the  changes the horizontal sweep speed within the range of 2 ns/div to 50 s/div.

5. Trigger Position

Use horizontal **POSITION**  knob to modify the parameter. Turn clockwise or counterclockwise to make the waveform move right or left, which will respectively cause the Delay parameter to decrease or increase. Press down the knob to automatically reset the parameter to zero as well as return the waveform's horizontal center to the middle of the screen.

6. Trigger position

Displays the trigger position of the waveform on the screen.

7. Frequency Counter

Displays the frequency of current waveform as trigger source.

8. Sample Rate/Memory Depth

Displays the current sample rate and memory depth of the oscilloscope. Use the Horizontal scale knob to modify the parameters.

9. Trigger Setting

Trigger Source  Displays the trigger source currently selected. Different labels are displayed when different trigger source are selected and the color of the trigger parameter area will change accordingly.

Coupling Mode  Displays coupling mode (DC/AC/LF Reject/HF Reject) of the current trigger source.

Trigger Level  Displays the trigger level value of the current waveform. Press down the knob to reset the parameter to 50% of the waveform.

Trigger Type  Displays the currently selected trigger type and trigger condition setting. Different labels are displayed when different trigger types are selected.



For example:  means triggered on positive slope side in edge trigger.

10. Channel Setting

Probe Attenuation Factor  Displays currently selected probe attenuation factor. All factors are: 0.1X/0.2X/0.5X/1X.../1000X/2000X/5000X/10000X.

Channel Coupling  Displays the selected coupling mode of the current channel. All modes are: DC/AC/GND.

Voltage Scale  Represents the voltage value of each grid on the vertical axis of the screen.

BW Limit  If the current "BW Limit" is "On", then the mark  is displayed.

Impedance  Displays currently selected impedance (1MΩ/50Ω) of the channel.

11. Trigger Level Position

Displays position of the current channel trigger level. Press down the knob to reset the level to vertical center of the waveform.

12. I/O Connection Status



Indicates the USB Host is connected.



Indicates the USB Device is connected.



Indicates the LAN port is connected.



Indicates the LAN port is not connected.

13. Menu

Displays menus of the currently selected function module. Press any menu softkey to perform corresponding setting.

Using Security Lock

Provisions for a Kensington-style lock are provided on the rear panel of the SDS2000X (Lock is not included). To use, align the lock with the lock hole and insert, turn the key clockwise to lock the instrument and then remove the key from the lock.

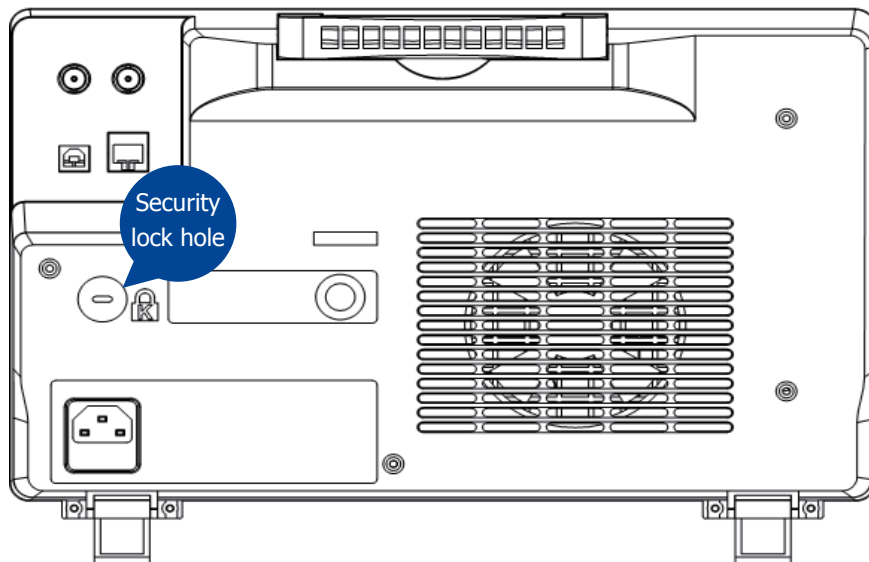

Trouble shooting

Possible problems and solutions are listed below. If one of these problems is encountered, please check each possible solution listed below it. If the issue is not resolved, please contact your dealer or Siglent directly.

1. The screen remains dark after power on:

- (1) Check if the power is correctly connected.
- (2) Check if the power switch is faulty.
- (3) Check whether the fuse is burned out. If the fuse is defective please replace with a fuse of the same size and ratings. If you have questions, please contact Siglent.
- (4) Restart the instrument after completing the steps listed above.
- (5) If these steps do not solve the problem, please contact Siglent.

2. After the signal is sampled, there is no corresponding waveform displaying:

- (1) Check to make certain the probe is correctly connected to the signal connecting cord.
- (2) Check to make certain the signal connecting cord is correctly connected to the BNC connector.
- (3) Verify that the probe is correctly connected to the item under test.
- (4) Verify that there is signal generated from the item under test.
- (5) Resample the signal.

3. The voltage amplitude measured is higher or lower than the actual value (the error usually occurs in use of the probe):

Verify that the attenuation coefficient of the current channel matches with the attenuation ratio of the probe.

4. A waveform is displayed but is not stable:

- (1) Check the trigger source: check whether the "Source" in menu of "TRIG" is the actual operating channel.
- (2) Check to see if the waveform is similar to what is expected. Make certain that the timebase is in the expected range. It is common to not see a signal if the timebase is set to sweep too fast.
- (3) Check the trigger type: "Edge" trigger suits to general signal and "Video" trigger suits to video signal. The correct trigger type setting can be important in obtaining a stable display.
- (4) Change the setting of trigger holdoff.

Trouble shooting



5. No display after pressing :

Check whether the trigger Mode is "Normal" or "Single", and if the trigger level exceeds the waveform range. If the trigger level is set too high, adjust the trigger level to the middle of the trace or change the trigger Mode to "Auto".

Note: Pressing "Auto Scale" might bring the waveform into view.

6. The displayed signal looks like a ladder.

- (1) The horizontal time base may be set too slow. Try increasing the time base sweep speed to improve the resolution of the displayed trace.
- (2) Lines between sampled points may cause the display to appear as a ladder when the display is in the Vector mode. Try using the Dots mode to see if this results in a more suitable display.

7. External USB drive is not recognized.

- (1) Check to make certain the USB flash drive is operating correctly in another instrument or PC.
- (2) Check if the USB Host can work normally.
- (3) Make sure the USB disk being used is of flash type, the instrument does not support USB of hard disk type.
- (4) Make sure the system format of used USB disk is FAT32.
- (5) Restart the instrument and then insert the USB to verify operation.
- (6) If a problem persists, please contact Siglent.

Contact us

SIGLENT TECHNOLOGIES CO., LTD.

Address: Blog No.4 & No.5, Antongda Industrial Zone, 3rd Liuxian Road, Bao'an District, Shenzhen, 518101, China.

Tel:+86-755-36615186

E-mail:sales@siglent.com

Http://www.siglent.com

