

SDG1000X Series

Function/Arbitrary
Waveform Generator

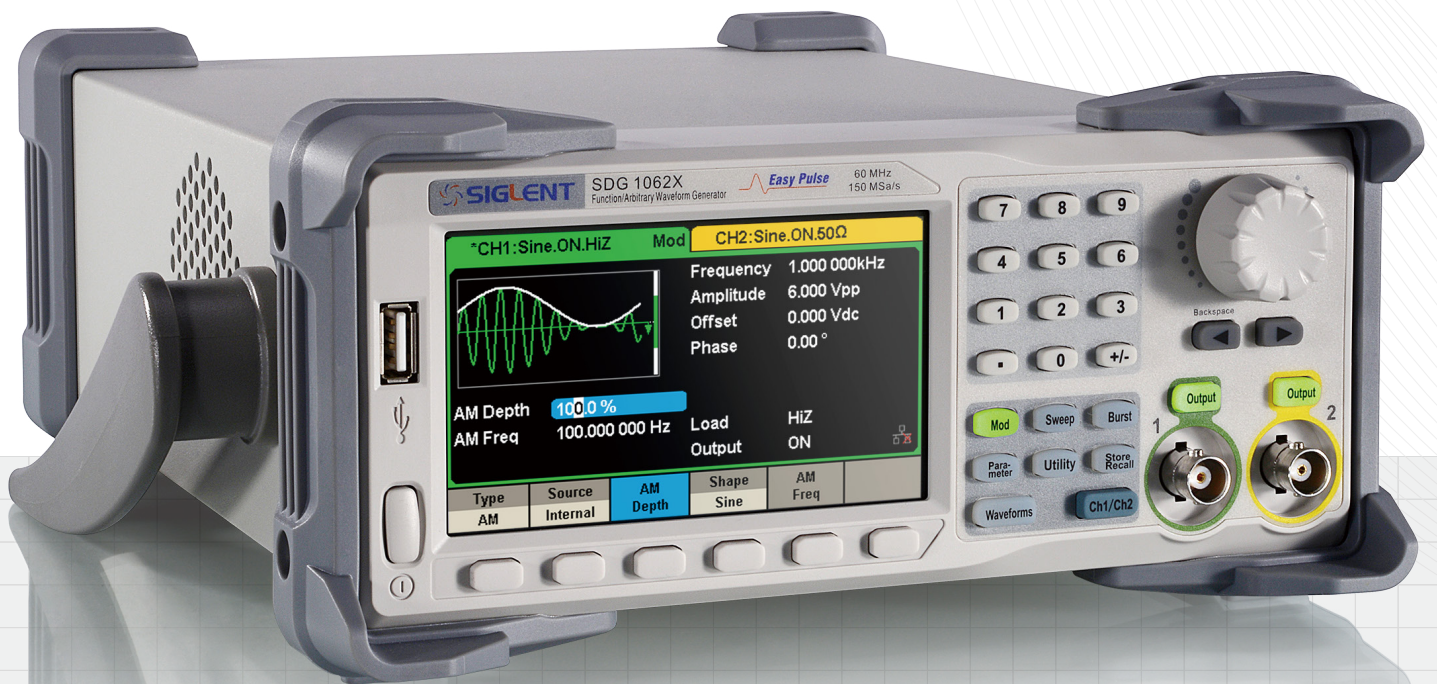

DataSheet-2019.03

SDG1062X

SDG1032X

Overview

SIGLENT's SDG1000X is a series of dual-channel function/arbitrary waveform generators with specifications that include up to 60 MHz maximum bandwidth, 150 MSa/s sampling rate and 14-bit vertical resolution. The proprietary EasyPulse & TrueArb technique helps to solve the weaknesses inherent in traditional DDS generators when generating pulse and arbitrary waveforms, and the special square generator is capable of generating square waveforms up to 60 MHz in frequency with low jitter. With these advantages, the SDG1000X can provide users with a variety of high fidelity / low jitter signals while meeting the growing requirements of a wide range of complex and varied applications.

Key Features

- Dual-channel, with bandwidth up to 60 MHz, and amplitude up to 20 Vpp
- 150 MSa/s sampling rate, 14-bit vertical resolution, and 16 kpts waveform length
- Innovative EasyPulse technology, capable of generating lower-jitter Pulse waveforms, brings a wide range and extremely high precision in pulse width and rise/fall times adjustment
- Innovative TrueArb technology, based on a point-by-point architecture, supports any 2 pts ~ 16 kpts Arb waveform with a sampling rate in range of 1 μ Sa/s ~ 30 MSa/s
- Special circuit for Square wave function, can generate Square waves up to 60 MHz with jitter less than 300 ps+0.05 ppm of period
- Plenty of analog and digital modulation types: AM, DSB-AM, FM, PM, FSK, ASK, PSK and PWM
- Sweep and Burst functions
- Harmonics Generator function
- Waveform Combining function
- High precision Frequency Counter
- Standard interfaces: USB Host, USB Device (USBTMC), LAN (VXI-11)
- 4.3" TFT-LCD display

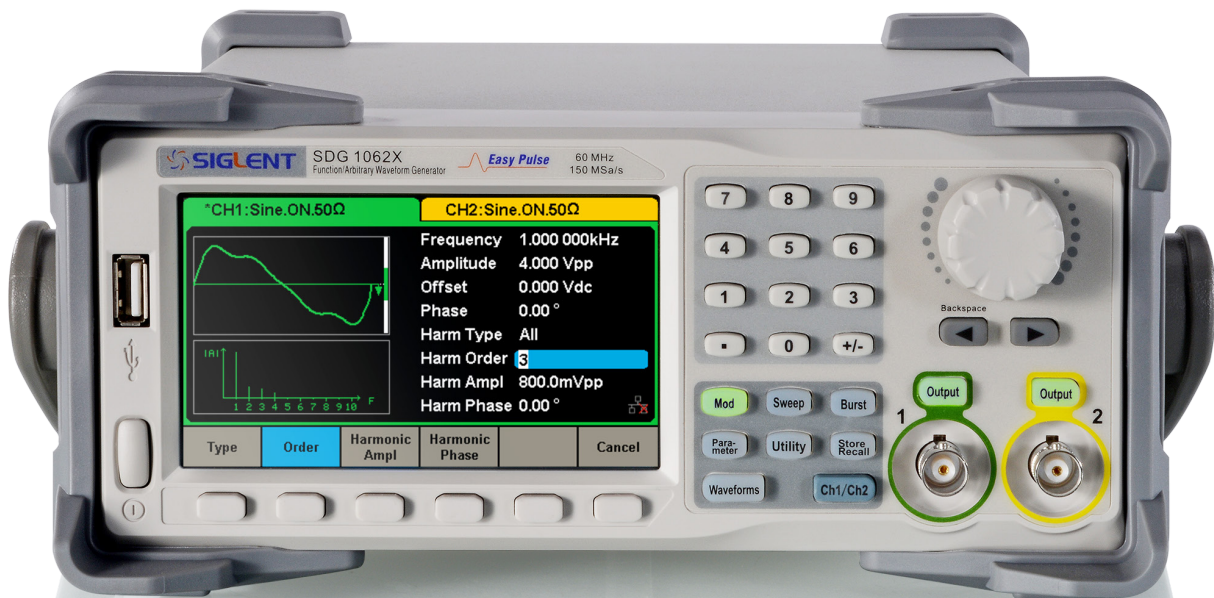

Models and Key Specifications

Product Model	SDG1062X	SDG1032X
Bandwidth	60 MHz	30 MHz
Sampling rate	150 MSa/s	
Vertical resolution	14-bit	
Waveform Length	16 kpts	
Num. of channels	2	
Max. amplitude	±10 V	
Display	4.3" display, 480 x 272 x RGB	
Interface	Standard: USB Host, USB Device, LAN	

Characteristics

Identical dual output-channels with high performance

Capable of outputting large signals at high frequencies. dual-channels, 20 Vpp amplitude can be guaranteed at up to 10 MHz.

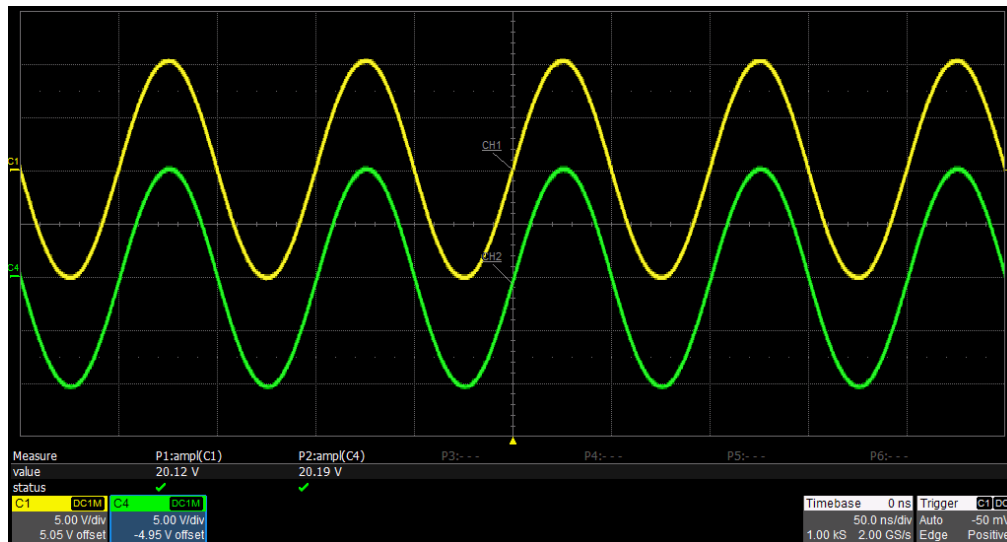

Low Distortion Output

With 0 dBm output, the THD (Total Harmonic Distortion) is less than 0.075%. Harmonics and spurs are less than -40 dBc throughout the entire bandwidth.

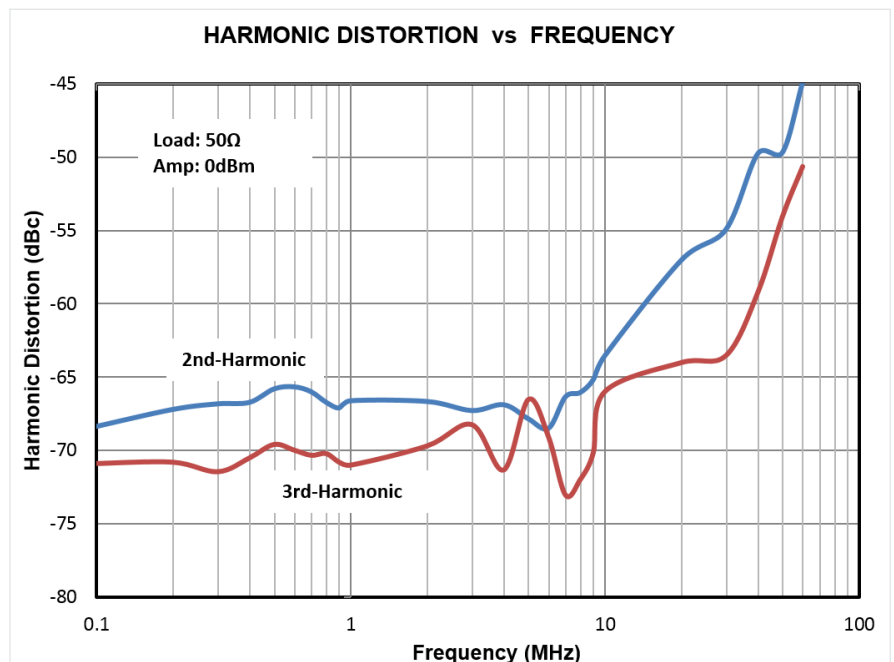

Innovative EasyPulse Technology

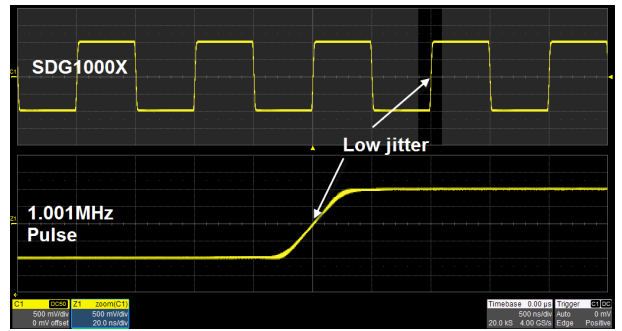
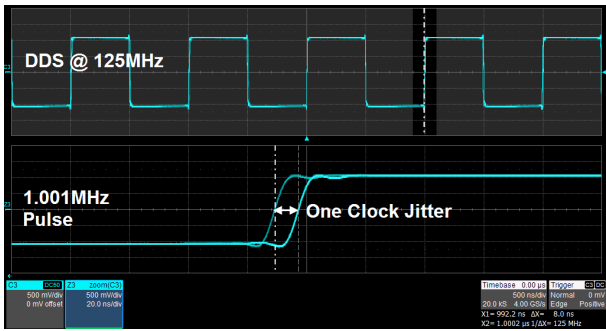

When a Pulse waveform is generated by a common DDS generator, there will be a one-clock-jitter if the sampling rate is not an integer-related multiple of the output frequency. SDG1000X EasyPulse technology successfully overcomes this weakness in DDS designs and helps to produce low jitter Pulse waveforms.

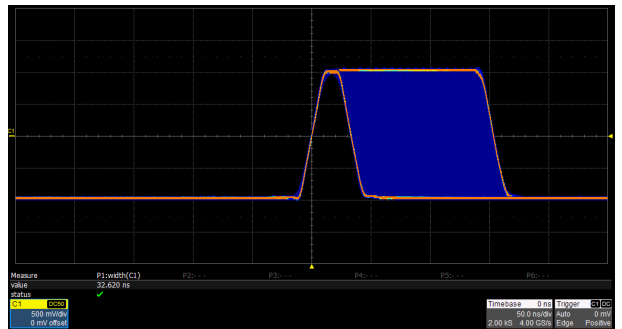
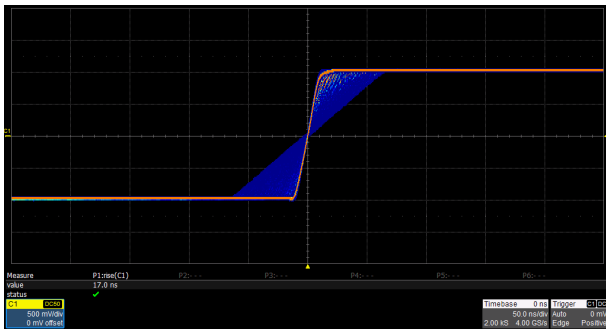

The rise/fall times can be set independently to the minimum of 16.8 ns at any frequency and to the maximum of 22.4 s. The adjustment step is as small as 100 ps. The Pulse width can be fine-tuned to the minimum of 32.6 ns with the adjustment step as small as 100ps.

High performance Square Waves

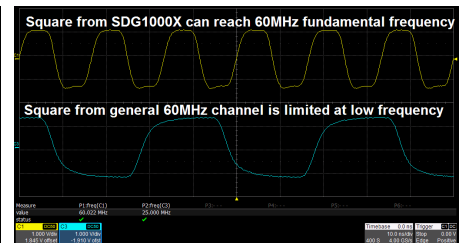
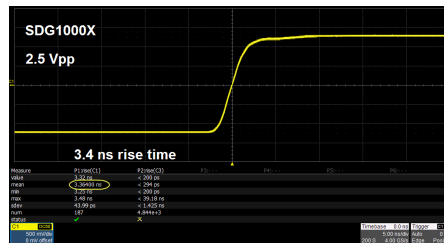
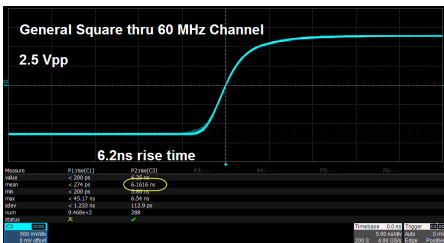

Benefiting from a special square-wave generating circuitry, the Square from the SDG1000X breaks the 60 MHz bandwidth barrier, reaching rise/fall times of less than 4.2 ns, and frequencies up to 60 MHz.

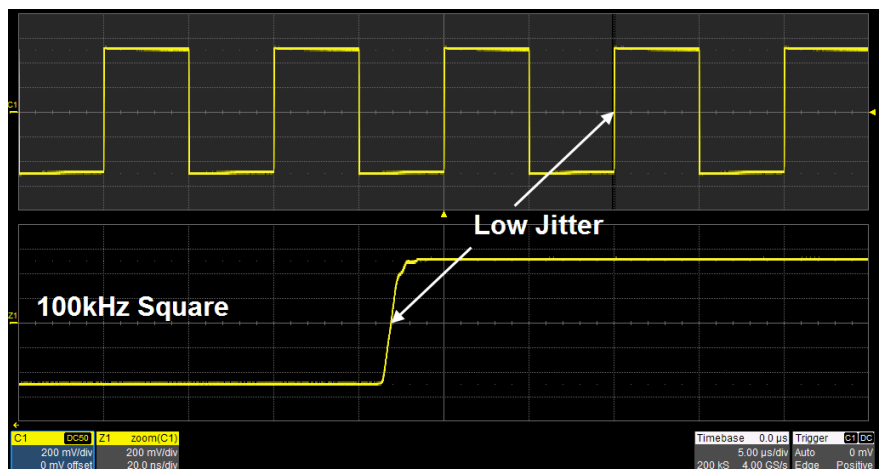

► The Square wave exhibits the same excellent jitter performance as the Pulse waveform.

Innovative TrueArb Technology

For arbitrary waveforms, TrueArb not only has all the advantages of traditional DDS, but also eliminates the probability that DDS may cause serious jitter and distortion.

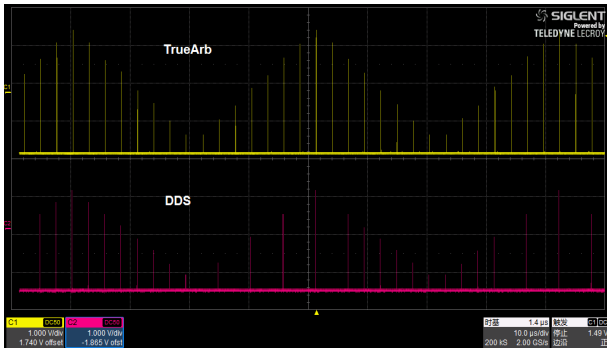

TrueArb generates arbitrary waveforms point by point, never skips any point so that it can reconstruct all the details of the waveform as defined.

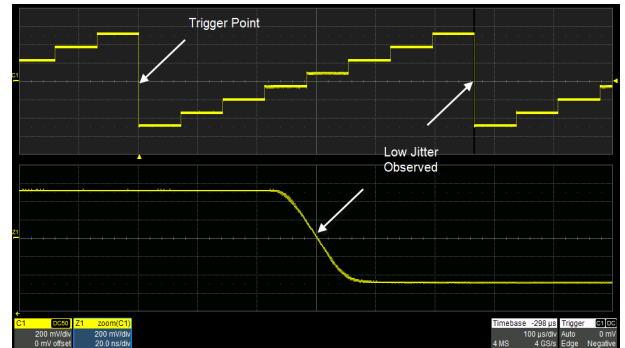

As with EasyPulse, TrueArb effectively overcomes the defect that DDS may cause the one-clock-jitter in arbitrary waveforms.

Modulation

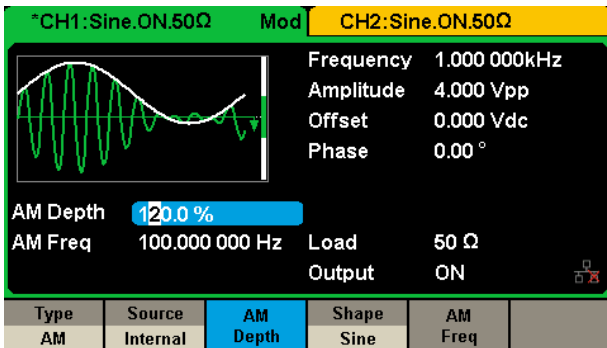

Multiple modulation types: AM, DSB-AM, FM, PM, FSK, ASK, PSK and PWM. The modulation source can be configured as "Internal" or "External".

Burst

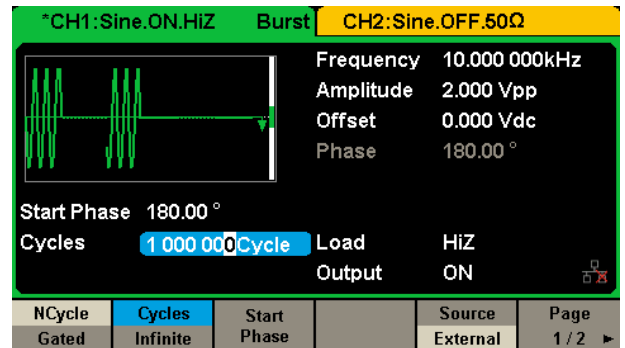

Two Burst modes, "N cycle" and "Gated". The Burst source can be configured as "Internal", "External" or "Manual".

Sweep

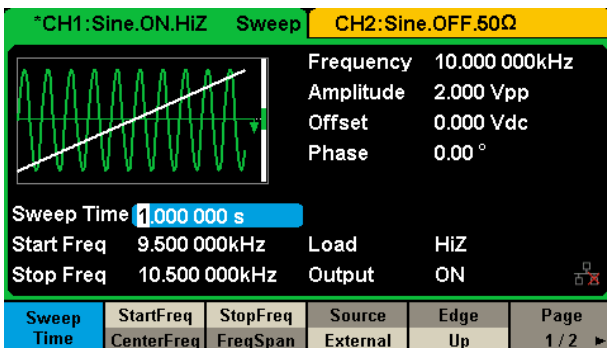

Two Sweep modes, "Linear" and "Log". Two Sweep directions, "Up" and "Down" and three Sweep sources, "Internal", "External" and "Manual".

Frequency Counter

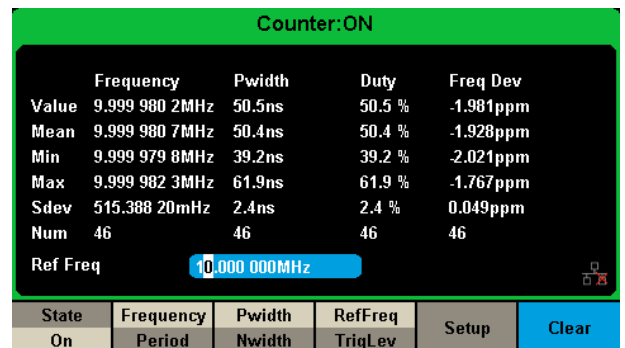

High precision Frequency Counter with an input frequency range of 0.1 Hz~200 MHz.

Harmonics Function

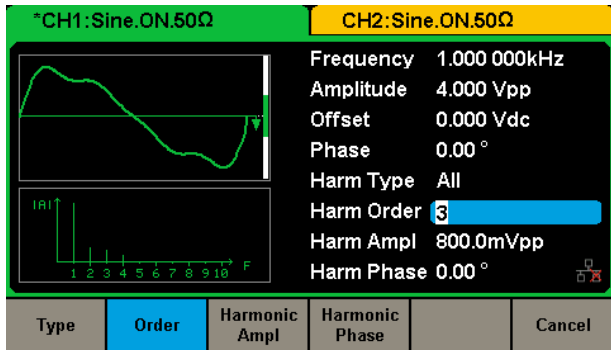

Up to 16 harmonics may be generated. Amplitude and phase of each harmonic can be set independently

Waveform Combining

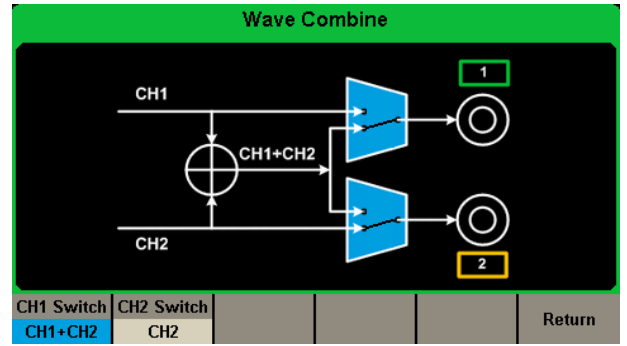

Capable of combining the waveforms of 2 channels from internal, providing more flexible tools to generate complex waveforms.

Arbitrary Waveform Software EasyWave

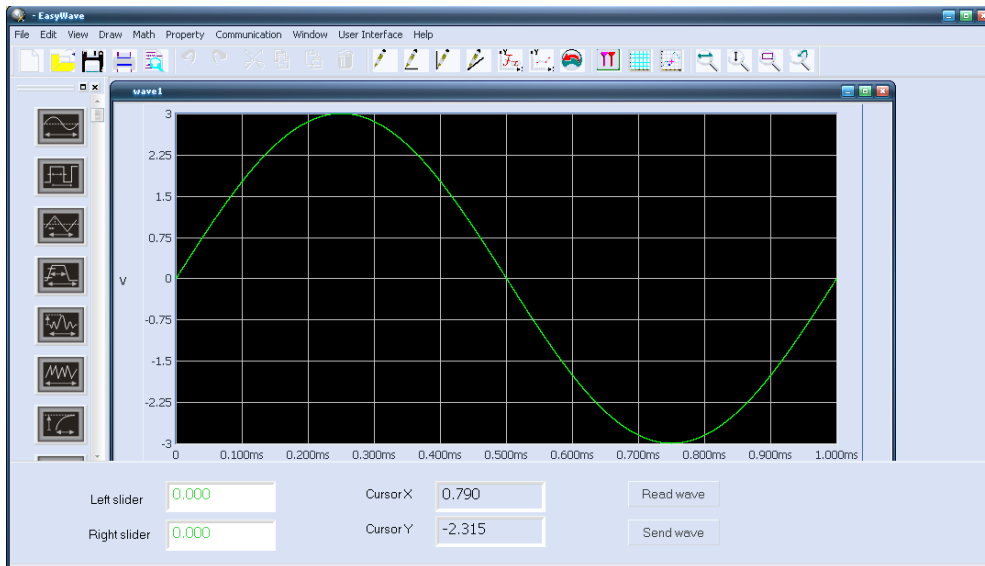

EasyWave is a powerful arbitrary waveform editing software program that supports several ways to generate arbitrary waveform such as manual drawing, line-drawing, equation-drawing, coordinate-drawing, etc. It is quite convenient for users to edit their own arbitrary waveforms through EasyWave.

Specifications

All specifications apply to both channels. Unless otherwise stated, all specifications are not guaranteed unless the following conditions are met:

- The generator is within calibration period of validity
- The generator has been working continuously for at least 30 minutes at a specified temperature (18°C ~ 28°C).

Frequency Characteristics

Parameter	Min.	Typ.	Max.	Unit	Condition
Resolution			1 μ	Hz	
Initial accuracy	-25		+25	ppm	1 st year, 0~40°C

Sine Characteristics

Parameter	Min.	Typ.	Max.	Unit	Condition
Frequency	1 μ		60 M	Hz	SDG1062X
			30 M		SDG1032X
Harmonic distortion			-60	dBc	0 dBm, 0~10 MHz (included)
			-50	dBc	0 dBm, 10~30 MHz (included)
			-40	dBc	0 dBm, 30~60 MHz
Total Harmonic Distortion			0.075		0 dBm, 10 Hz ~ 20 kHz
Non-harmonic spurious			-65	dBc	0 dBm, 0~10 MHz (included)
			-55	dBc	0 dBm, 10~30 MHz (included)
			-40	dBc	0 dBm, 30~60 MHz

Square Characteristics

Parameter	Min.	Typ.	Max.	Unit	Condition
Frequency	1 μ		60 M	Hz	SDG1062X
			30 M		SDG1032X
Rise/fall times			4.2	ns	10% ~ 90%, 1 Vpp, 50 Ω load
			3.8	ns	10% ~ 90%, 2.5 Vpp, 50 Ω load
Overshoot			3	%	100 kHz, 1 Vpp, 50 Ω load
Duty cycle	0.001		99.999	%	Limited by frequency setting
Jitter (rms), Cycle to cycle			300 ps + 0.05 ppm of period		1 Vpp, 50 Ω load

Pulse Characteristics

Parameter	Min.	Typ.	Max.	Unit	Condition
Frequency	1 μ		12.5 M	Hz	
Pulse width	32.6			ns	
Pulse width accuracy			$\pm(0.01\%+1\text{ ns})$		
Rise/fall times	16.8 n		22.4	s	10% ~ 90%, 1 Vpp, 50 Ω load , Subject to pulse width limits
Overshoot			3	%	100 kHz, 1 Vpp
Duty cycle	0.001		99.999	%	Limited by frequency setting
Duty cycle resolution	0.001			%	
Jitter (rms) cycle to cycle			300 ps + 0.05 ppm of period	ps	1 Vpp, 50 Ω load

Noise Characteristics

Parameter	Min.	Typ.	Max.	Unit	Condition
-3 dB bandwidth	60			MHz	

Ramp Characteristics

Parameter	Min.	Typ.	Max.	Unit	Condition
Frequency	1 μ		500 k	Hz	
Symmetry	0		100	%	
Linearity			1	%	Percentage of peak-peak output, 1 kHz, 1 Vpp, 50%

Arbitrary Wave characteristics

Parameter	Min.	Typ.	Max.	Unit	Condition
Frequency	1 μ		6 M	Hz	DDS mode
Waveform length	16 k			pts	DDS mode
	2		16 k	pts	TrueArb mode
Sampling rate	150 M			Sa/s	DDS mode
	1 μ		30 M	Sa/s	TrueArb mode
Vertical resolution	14			bit	
Jitter		6.7		ns	DDS mode, pk-pk
			300	ps	TrueArb mode, cycle-cycle rms, 2 pts, 20.1 MSa/s
Types of built-in Arb	196				

DC Characteristics

Parameter	Min.	Typ.	Max.	Unit	Condition
Range	-10		10	V	HiZ load
	-5		5	V	50 Ω load
Accuracy	$\pm(1\%+3 \text{ mV})$				HiZ load

Harmonic Output Characteristics

Parameter	Min.	Typ.	Max.	Unit	Condition
Order			16		
Type	Even, Odd, All				

Output Characteristics

Parameter	Min.	Typ.	Max.	Unit	Condition
Range (Specified) (Note 1)	4 m		20	Vpp	≤ 10 MHz, HiZ load
	4 m		10	Vpp	>10 MHz, HiZ load
Range (Setting) (Note 1)	2 m		20	Vpp	≤ 10 MHz, HiZ load
	2 m		10	Vpp	>10 MHz, HiZ load
Accuracy	$\pm(1\%+1 \text{ mVpp})$				10 kHz sine, 0 V offset
Amplitude flatness	-0.3		+0.3	dB	50 Ω load , 2.5 Vpp, compare to 10 kHz sine,
Output impedance	49.5	50	50.5	Ω	10 kHz sine
Output current	-200		200	mA	
Crosstalk (CH1 - CH2 / CH2 - CH1)			-60	dBc	CH1= CH2= 0 dBm, Sine, 50 Ω load

Note 1: The specification will be divided by 2 when applied to a 50 Ω load.

Modulation Characteristics**AM**

Parameter	Min.	Typ.	Max.	Unit	Condition
Carrier	Sine, Square, Ramp, Arb				
Modulation Source	Internal/External				
Modulating wave	Sine, Square, Ramp, Noise, Arb				
Modulation depth	0		120	%	
Modulation frequency	1 m		20 k	Hz	While modulation source is "Internal"

FM

Parameter	Min.	Typ.	Max.	Unit	Condition
Carrier	Sine, Square, Ramp, Arb				
Modulation Source	Internal/External				
Modulating wave	Sine, Square, Ramp, Noise, Arb				
Frequency deviation	0		0.5*BW		BW is the max. output frequency limited by frequency setting
Modulation frequency	1 m		20 k	Hz	While modulation source is "Internal"

Modulation Characteristics**PM**

Parameter	Min.	Typ.	Max.	Unit	Condition
Carrier	Sine, Square, Ramp, Arb				
Modulation Source	Internal/External				
Modulating wave	Sine, Square, Ramp, Noise, Arb				
Phase deviation	0		360	°	
Modulation frequency	1 m		20 k	Hz	While modulation source is "Internal"

ASK

Parameter	Min.	Typ.	Max.	Unit	Condition
Carrier	Sine, Square, Ramp, Arb				
Modulation Source	Internal/External				
Modulating wave	Square with 50% duty cycle				
Keying frequency	1 m		50 k	Hz	Limited by frequency setting while modulation source is "Internal"

FSK

Parameter	Min.	Typ.	Max.	Unit	Condition
Carrier	Sine, Square, Ramp, Arb				
Modulation Source	Internal/External				
Modulating wave	Square with 50% duty cycle				
Modulation frequency	1 m		50 k	Hz	While modulation source is "Internal"

PWM

Parameter	Min.	Typ.	Max.	Unit	Condition
Carrier	Pulse				
Modulation Source	Internal/External				
Modulating wave	Sine, Square, Ramp, Noise, Arb				
Modulation frequency	1 m		1 M	Hz	While modulation source is "Internal"
Pulse width deviation resolution	6.67			ns	

Burst Characteristics

Parameter	Min.	Typ.	Max.	Unit	Condition
Carrier	Sine, Square, Ramp, Pulse, Noise, Arb				
Type	Count(1-1000000cycles), Infinite, Gated				
Carrier frequency	2 m		BW	Hz	BW is the max. output frequency
Start/Stop phase	0		360	°	
Internal period	1 μ		1000	s	
Trigger source	Internal, External, Manual				
Gated source	Internal/External				
Trigger delay			100	s	

Sweep Characteristics

Parameter	Min.	Typ.	Max.	Unit	Condition
Carrier	Sine, Square, Ramp, Arb				
Type	Linear, Log				
Direction	Up, Down				
Carrier frequency	1 μ		BW	Hz	BW is the max. output frequency
Sweep time	1 m		500	s	
Trigger source	Internal, External, Manual				

Frequency Counter Characteristics

Parameter	Min.	Typ.	Max.	Unit	Condition
Function	Frequency, Period, Positive/Negative pulse width, Duty cycle				
Coupling mode	AC, DC, HF REJ				
Frequency range	100m		200 M	Hz	DC coupling
	10		200 M	Hz	AC coupling
Input amplitude	100 mVrms		± 2.5 V		DC coupling, < 100 MHz
	200 mVrms		± 2.5 V		DC coupling, 100 MHz ~ 200 MHz
	100 mVrms		5 Vpp		AC coupling, < 100 MHz
	200 mVrms		5 Vpp		AC coupling, 100 MHz ~ 200 MHz
Input impedance		1 M		Ω	

Reference Clock Input/Output**Reference Clock Input**

Parameter	Min.	Typ.	Max.	Unit	Condition
Frequency		10 M		Hz	
Amplitude	1.4			Vpp	
Input impedance	5			k Ω	AC coupling

Reference Clock Output

Parameter	Min.	Typ.	Max.	Unit	Condition
Frequency		10 M		Hz	Synchronized to internal reference clock
Amplitude	2	3.3		Vpp	HiZ load
Output impedance		50		Ω	

Auxiliary In/Out Characteristics**Trigger Input**

Parameter	Min.	Typ.	Max.	Unit	Condition
V_{IH}	2		5.5	V	
V_{IL}	-0.5		0.8	V	
Input impedance	100			k Ω	
Pulse width	100			ns	
Response time			100	ns	Sweep
			600	ns	Burst

Trigger Output

Parameter	Min.	Typ.	Max.	Unit	Condition
V_{OH}	3.8			V	$I_{OH} = -8$ mA
V_{OL}			0.44	V	$I_{OL} = 8$ mA
Output impedance		100		Ω	
Frequency			1	MHz	

Sync Output

Parameter	Min.	Typ.	Max.	Unit	Condition
V_{OH}	3.8			V	$I_{OH} = -8$ mA
V_{OL}			0.44	V	$I_{OL} = 8$ mA
Output impedance		100		Ω	
Pulse width		500		ns	
Frequency			10	MHz	
Jitter (pk-pk)		6.7		ns	

Auxiliary In/Out Characteristics

Modulation Input

Parameter	Min.	Typ.	Max.	Unit	Condition
Frequency	0		50	kHz	
Input impedance	10			kΩ	
Amplitude@ 100% Modulation depth	11	12	13	Vpp	

General Characteristics

Power

Parameter	Min.	Typ.	Max.	Unit	Condition
Voltage	100 - 240 Vrms (± 10%), 50 / 60 Hz 100 - 120 Vrms (± 10%), 400 Hz				
Power consumption		21	50	W	Dual channels, Sine, 1kHz, 10Vpp, 50Ω load

Display

Parameter	Min.	Typ.	Max.	Unit	Condition
Color depth		24		bit	
Contrast ratio		350:1			
Luminance		300		cd/m ²	

Environment

Parameter	Min.	Typ.	Max.	Unit	Condition
Operating temperature	0		40	°C	
Storage temperature	-20		60	°C	
Operating humidity	5		90	%	≤ 30 °C
	5		50	%	40 °C
Non-operating humidity	5		95	%	
Operating altitude			3048	m	≤ 30 °C
Non-operating altitude			15000	m	

Calibration

Parameter	Min.	Typ.	Max.	Unit	Condition
Calibration interval		1		year	

Mechanical

Parameter	Min.	Typ.	Max.	Unit	Condition
Dimensions	W×H×D = 260.3 mm×107.2 mm×295.7 mm				
Net weight		3.43		kg	
Gross weight		4.35		kg	

Compliance

LVD	IEC 61010-1:2010
EMC	EN61326-1:2013

Ordering Information

Product Description

60 MHz, 2 CH, 150 MSa/s, 14 bit	SDG1062X
30 MHz, 2 CH, 150 MSa/s, 14 bit	SDG1032X

Standard Configurations

Quick Start -1	
Power Cord-1	
Calibration Certificate -1	
USB Cable -1	

Optional Configurations

BNC Coaxial Cable	SDG-BNC
20 dB Attenuator	ATT-20dB
10W Power Amplifier	SPA1010

SDG1000X Series

Function/Arbitrary
Waveform Generator



About SIGLENT

SIGLENT is an international high-tech company, concentrating on R&D, sales, production and services of electronic test & measurement instruments.

SIGLENT first began developing digital oscilloscopes independently in 2002. After more than a decade of continuous development, SIGLENT has extended its product line to include digital oscilloscopes, function/arbitrary waveform generators, digital multimeters, DC power supplies, spectrum analyzers, isolated handheld oscilloscopes and other general purpose test instrumentation. Since its first oscilloscope, the ADS7000 series, was launched in 2005, SIGLENT has become the fastest growing manufacturer of digital oscilloscopes. We firmly believe that today SIGLENT is the best value in electronic test & measurement.

Headquarter:

SIGLENT TECHNOLOGIES CO., LTD.
Add: Bldg No.4 & No.5, Antongda Industrial
Zone, 3rd Liuxian Road, Bao'an District,
Shenzhen, 518101, China.
Tel: + 86 755 3661 5186
Fax: + 86 755 3359 1582
Email: sales@siglent.com;
Website: <http://www.siglent.com/ens/>

USA:

SIGLENT Technologies America, Inc
6557 Cochran Rd Solon, Ohio 44139
Tel: 440-398-5800
Toll Free: 877-515-5551
Fax: 440-399-1211
Email: info@siglent.com
Website: www.siglentamerica.com

Europe:

SIGLENT TECHNOLOGIES EUROPE GmbH
ADD: Liebigstrasse 2-20, Gebaeude 14,
22113 Hamburg Germany
Tel: +49(0)-819-95946
Fax: +49(0)-819-95947
Email: info-eu@siglent.com
Website: www.siglenteu.com

Follow us on
Facebook: SiglentTech

