

# Programming Guide

## Digital Oscilloscopes Series

RC01020-E01C

---

# Catalogue

Programming Overview .....	4
Build communication.....	4
Install NI-VISA.....	4
Connect the instrument .....	8
How To Remote Control.....	9
a. User-defined Programming .....	9
b .Send SCPI Commands via NI-VISA .....	9
About these Commands & Queries .....	10
How are they listed?.....	10
How are they described?.....	10
Where can they be used? .....	10
Command Notation.....	12
Table of Commands & Queries .....	13
Programming Examples .....	148
Example of VC++ .....	149
Example of VB.....	158
Example of MATLAB.....	165
Example of LabVIEW .....	168
Example of C# .....	172

Index ..... 175

## Programming Overview

This chapter introduces how to execute remote communications between a SIGLENT digital oscilloscope and the computer. It also introduces how to establish a remote control link over a communication bus.

## Build communication

### Install NI-VISA

Before programming, you need to install National Instruments NI-VISA library, which you can download from the National Instruments web-site. Currently, NI-VISA is packaged in two versions: a full version and a Run-Time Engine version. The full version includes the NI device drivers and a tool named NI MAX that is a user interface to control the device. The Run-Time Engine is much smaller than the full version and only includes NI device driver.

For example, you can get the NI-VISA 5.4 full version from:  
<http://www.ni.com/download/ni-visa-5.4/4230/en/>.

You also can download NI-VISA Run-Time Engine 5.4 to your PC and install it as the default selection. Its installation process is similar with the full version.

After you downloaded the file you can follow the steps below to install it:

a. Double click the visa540\_full.exe, dialog shown as below:

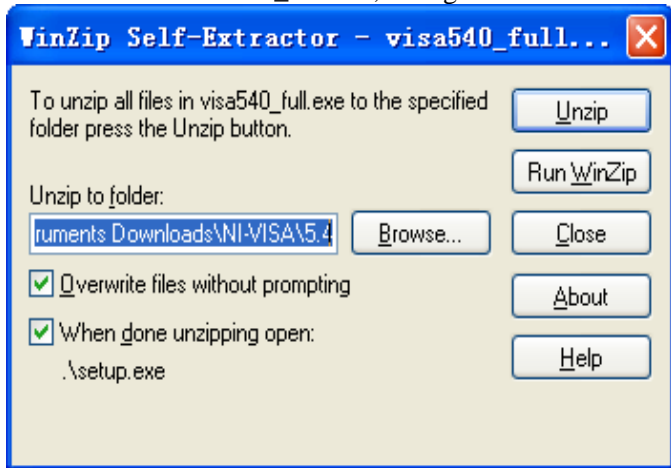

b. Click Unzip, the installation process will automatically launch after unzipping files. If your computer needs to install .NET Framework 4, its Setup process will auto start.



c. The NI-VISA installing dialog is shown above. Click Next to

start the installation process.

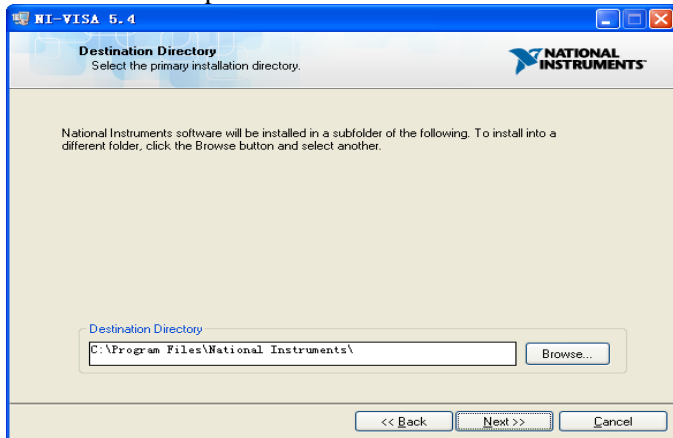

Set the install path, default path is “C:\Program Files\National Instruments\”, you can change it. Click Next, dialog shown as above.

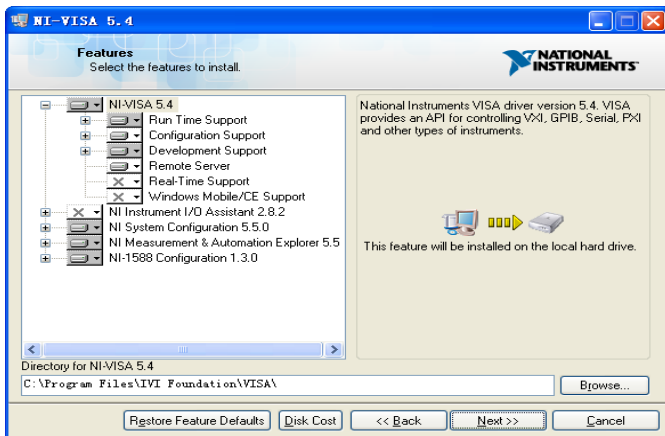

d. Click Next twice, in the License Agreement dialog, select the

“I accept the above 2 License Agreement(s).”, and click Next, dialog shown as below:

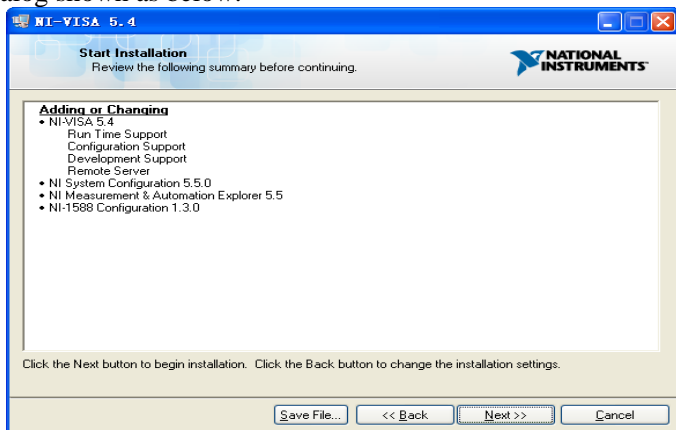

e. Click Next to run installation.

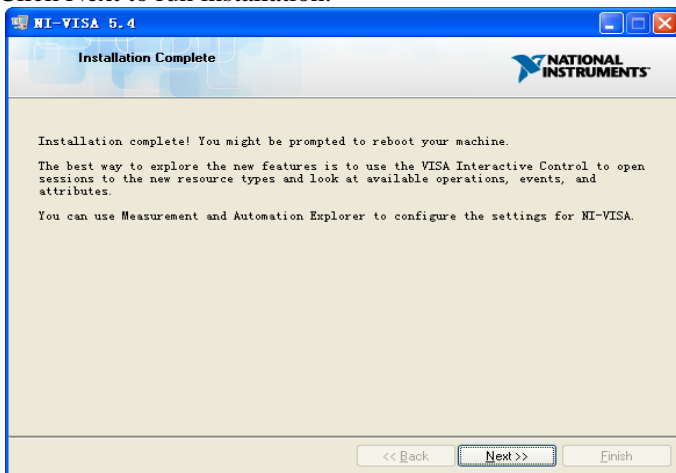

Now the installation is complete, reboot your PC.

## Connect the instrument

Depending on your specific model your oscilloscope may be able to communicate with a PC through the USB or LAN interface. This manual takes the USB as an example. (For instructions to communicate with a PC through the LAN interface see the User Manual.)

a. Connect the USB Device interface at the rear panel of the oscilloscope and the USB Host interface of the PC using a USB cable. Assuming your PC is already turned on, turn on your oscilloscope and your PC will display the “Device Setup” screen as it automatically installs the device driver as shown below.

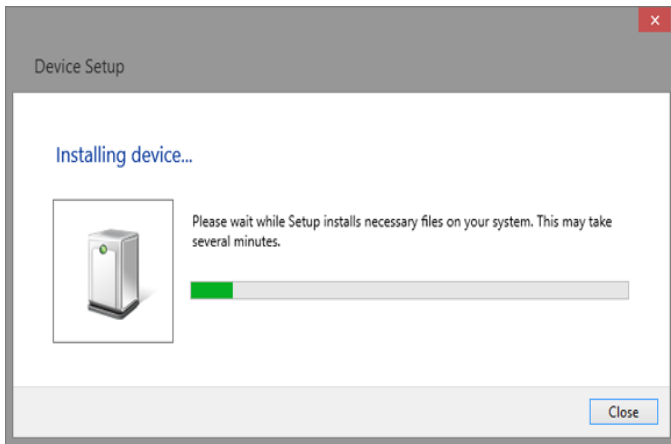

b. Wait for the installation to complete and then proceed to the next step.



## How To Remote Control

### a. User-defined Programming

Users can use SCPI commands to program and control the digital oscilloscope. For details, refer to the introductions in "**Programming Examples**".

### b .Send SCPI Commands via NI-VISA

You can control the oscilloscope remotely by sending SCPI commands via NI-VISA software.

## About these Commands & Queries

This section lists describes the remote control commands and queries recognized by the instrument. All commands and queries can be executed in either local or remote state.

The description for each command or query, with syntax and other information, begins on a new page. The name (header) is given in both long and short form at the top of the page, and the subject is indicated as a command or query or both. Queries perform actions such as obtaining information, and are recognized by the question mark (?) following the header.

### How are they listed?

The descriptions are listed in alphabetical order according to their long form. Thus the description of ATTENUATION, whose short form is ATTN, is listed before that of AUTO SETUP, whose short form is ASET.

### How are they described?

In the descriptions themselves, a brief explanation of the function performed is given. This is followed by a presentation of the formal syntax, with the header given in Upper-and-Lower-Case characters and the short form derived from it in ALL UPPER-CASE characters. Where applicable, the syntax of the query is given with the format of its response.

### Where can they be used?

The commands and queries listed here can be used for all Siglent's Digital Oscilloscope Series digital instruments.

<b>Applicable to the following models</b>
SDS1000CML/CML+
SDS1000DL/DL+
SDS1000CNL/CNL+
SDS1000/1000X/1000X-S/1000X+/1000X-E
SDS2000/SDS2000X

Certain commands are only applicable to SPO oscilloscopes models and are described accordingly.

SPO oscilloscopes models are in the table below.

<b>SPO models</b>
SDS1000X/1000X+/SDS1000X-E
SDS2000/2000X

### **What is an SPO model?**

SPO model uses Siglent-innovated waveform acquisition and graphics processing engine which supports high capture rate, multi-level intensity grading and color temperature display, with deep memory storage and the use of new digital trigger technology supports rich trigger types and precise trigger. All of these technologies are collectively known as SPO (Super Phosphor Oscilloscope) technology.

## Command Notation

The following notation is used in the commands:

- < > Angular brackets enclose words that are used as placeholders, of which there are two types: the header path and the data parameter of a command.
- : = A colon followed by an equals sign separates a placeholder from the description of the type and range of values that may be used in a command instead of the placeholder.
- { } Braces enclose a list of choices, one of which one must be made.
- [ ] Square brackets enclose optional items.
- ... An ellipsis indicates that the items both to its left and right may be repeated a number of times.

As an example, consider the syntax notation for the command to set the vertical input sensitivity:

```
<channel>:VOLT_DIV <v_gain>  
<channel> := {C1, C2, C3, C4}  
<v_gain>:= 2 mV to 10 V
```

The first line shows the formal appearance of the command, with <channel> denoting the placeholder for the header path and <v\_gain> the placeholder for the data parameter specifying the desired vertical gain value. The second line indicates that one of four channels must be chosen for the header path. And the third explains that the actual vertical gain can be set to any value between 2 mV and 10 V.

## Table of Commands & Queries

<i>Short Form</i>	<i>Long Form</i>	<i>Subsystem</i>	<i>What the Command or Query Does</i>
<a href="#">ACQW</a>	ACQUIRE_WAY	ACQUISITION	Specifies the acquisition mode.
<a href="#">ALST?</a>	ALL_STATUS?	STATUS	Reads and clears the contents of all status registers.
<a href="#">ARM</a>	ARM_ACQUISITION	ACQUISITION	Changes acquisition state from “stopped” to “single”.
<a href="#">ATTN</a>	ATTENUATION	ACQUISITION	Selects the vertical attenuation factor of the probe
<a href="#">ACAL</a>	AUTO_CALIBRATE	MISCELLANEOUS	Enables or disables automatic calibration.
<a href="#">ASET</a>	AUTO_SETUP	ACQUISITION	Adjusts vertical, time base and trigger parameters.
<a href="#">AUTTS</a>	AUTO_TYPESET	ACQUISITION	Selects the display type of automatic setup.
<a href="#">AVGA</a>	AVERAGE_ACQUIRE	ACQUISITION	Selects the average times of average acquisition.
<a href="#">BWL</a>	BANDWIDTH_LIMIT	ACQUISITION	Enables/disables the bandwidth-limiting low-pass filter.
<a href="#">BUZZ</a>	BUZZER	MISCELLANEOUS	Controls the built-in piezo-electric buzzer.
<a href="#">*CAL?</a>	*CAL?	MISCELLANEOUS	Performs complete internal calibration of the instrument.
<a href="#">CHDR</a>	COMM_HEADER	COMMUNICATION	Controls formatting of query responses.
<a href="#">*CLS</a>	*CLS	STATUS	Clears all status data registers.
<a href="#">CMR?</a>	CMR?	STATUS	Reads and clears the Command error Register (CMR).
<a href="#">CONET</a>	COMM_NET	COMMUNICATION	Specifies network addresses of scope and printers.
<a href="#">CPL</a>	COUPLING	ACQUISITION	Selects the specified input channel’s coupling mode.

## Digital Oscilloscopes Series

<a href="#">CRMS</a>	CURSOR_MEASURE	CURSOR	Specifies the type of cursor/parameter measurement.
<a href="#">CRST</a>	CURSOR_SET?	CURSOR	Allows positioning of any one of eight cursors.
<a href="#">CRVA?</a>	CURSOR_VALUE?	CURSOR	Returns trace values measured by specified cursors.
<a href="#">CSVS</a>	CSV_SAVE	SAVE/RECALL	Saves specified waveform data of CSV format to USB device.
<a href="#">CYMT</a>	CYMOMETER	FUNCTION	Returns the current cymometer value which displaying on the screen.
<a href="#">DATE</a>	DATE	MISCELLANEOUS	Changes the date/time of the internal real-time clock.
<a href="#">DDR?</a>	DDR?	STATUS	Clears the Device Dependent Register (DDR).
<a href="#">DEF</a>	DEFINE?	FUNCTION	Specifies math expression for function evaluation.
<a href="#">DELF</a>	DELETE_FILE	MASS STORAGE	Deletes files from mass storage.
<a href="#">DIR</a>	DIRECTORY	MASS STORAGE	Creates and deletes file directories.
<a href="#">DTJN</a>	DOT_JOIN	DISPLAY	Controls the interpolation lines between data points.
<a href="#">*ESE</a>	*ESE	STATUS	Sets the Standard Event Status Enable register (ESE).
<a href="#">*ESR?</a>	*ESR?	STATUS	Reads, clears the Event Status Register (ESR).
<a href="#">EXR?</a>	EXR?	STATUS	Reads, clears the Execution error Register (EXR).
<a href="#">FLNM</a>	FILENAME	MASS STORAGE	Changes default filenames.
<a href="#">FPAR</a>	FRAME_PARAM	HISTORY	Get frame param.
<a href="#">FRAM</a>	FRAME_SET	HISTORY	History Frame No. set.
<a href="#">FRTR</a>	FORCE_TRIGGER	ACQUISITION	Forces the instrument to make one acquisition.
<a href="#">FTIM</a>	FRAME_TIME	HISTORY	Get frame Acq. Time.
<a href="#">FVDISK</a>	FORMAT_VDISK	MASS STORAGE	Reads the capability of the USB device.
<a href="#">FILT</a>	FILTER	FUNCTION	Enables or disables the

## Digital Oscilloscopes Series

			filter of specified source.
<a href="#">FILTS</a>	FILT_SET	FUNCTION	Selects the type of filter, and sets the limit value of filter.
<a href="#">FFTW</a>	FFT_WINDOW	FUNCTION	Selects the window of FFT.
<a href="#">FFTZ</a>	FFT_ZOOM	FUNCTION	Selects the zoom in/out times of FFT trace.
<a href="#">FFTS</a>	FFT_SCALE	FUNCTION	Selects the vertical scale of FFT trace.
<a href="#">FFTF</a>	FFT_FULLSCREEN	FUNCTION	Enables or disables to display the FFT trace full screen.
<a href="#">GRDS</a>	GRID_DISPLAY	DISPLAY	Selects the type of grid
<a href="#">GCSV</a>	GET_CSV	WAVEFORMTRANS	Specifies waveform data of format to controller.
<a href="#">HMAG</a>	HOR_MAGNIFY	DISPLAY	Horizontally expands the selected expansion trace.
<a href="#">HPOS</a>	HOR_POSITION	DISPLAY	Horizontally positions intensified zone's center.
<a href="#">HCSU</a>	HARDCOPY_SETUP	HARD COPY	Configures the hard-copy driver.
<a href="#">*IDN?</a>	*IDN?	MISCELLANEOUS	For identification purposes.
<a href="#">ILVD</a>	INTERLEAVED	ACQUISITION	Reads, clears INternal state change Register (INR).
<a href="#">INTS</a>	INTENSITY	DISPLAY	Sets the grid or trace/text intensity level.
<a href="#">INR?</a>	INR?	STATUS	Reads, clears INternal state change Register (INR).
<a href="#">INVS</a>	INVERT_SET	DISPLAY	Invert the trace or the math waveform of specified source.
<a href="#">LOCK</a>	LOCK	MISCELLANEOUS	Lock keyboard
<a href="#">MTVP</a>	MATH_VERT_POS	ACQUISITION	Controls the vertical position of math waveform of specified source.
<a href="#">MTVD</a>	MATH_VERT_DIV	ACQUISITION	Controls the vertical sensitivity of math waveform of specified source.

## Digital Oscilloscopes Series

<a href="#">MEAD</a>	MEASURE_DELY	ACQUISITION	Controls the vertical sensitivity of math waveform of specified source.
<a href="#">MENU</a>	MENU	DISPLAY	Enables or disables to display the current menu.
<a href="#">MSIZ</a>	MEMORY_SIZE	FUNCTION	Returns the maximal memory size
<a href="#">OFST</a>	OFFSET	ACQUISITION	Allows output channel vertical offset adjustment.
<a href="#">*OPC</a>	*OPC	STATUS	Sets the OPC bit in the Event Status Register (ESR).
<a href="#">*OPT?</a>	*OPT?	MISCELLANEOUS	Identifies oscilloscope options.
<a href="#">PACL</a>	PARAMETER_CLR	CURSOR	Clears all current parameters in Custom, Pass/Fail.
<a href="#">PACU</a>	PARAMETER_CUSTO M	CURSOR	Controls parameters with customizable qualifiers.
<a href="#">PAVA?</a>	PARAMETER_VALU E?	CURSOR	Returns current parameter, mask test values.
<a href="#">PDET</a>	PEAK_DETECT	ACQUISITION	Switches the peak detector ON and OFF.
<a href="#">PERS</a>	PERSIST	DISPLAY	Enables or disables the persistence display mode.
<a href="#">PESU</a>	PERSIST_SETUP	DISPLAY	Selects display persistence duration.
<a href="#">PNSU</a>	PANEL_SETUP	SAVE/RECALL	Complements the *SAV/*RST commands.
<a href="#">PFDS</a>	PF_DISPLAY	FUNCTION	Enables or disables to display the test and the message options of pass/fail.
<a href="#">PFST</a>	PF_SET	FUNCTION	Sets the X mask and the Y mask.
<a href="#">PFSL</a>	PF_SAVELOAD	SAVE/RECALL	Saves or recalls the created mask setting.
<a href="#">PFCT</a>	PF_CONTROL	FUNCTION	Selects the “operate”, “output” and the “stop on output” which are the options of pass/fail.
<a href="#">PFCM</a>	PF_CREATEM	FUNCTION	Creates the mask of the pass/fail.
<a href="#">PFDD</a>	PF_DATEDIS	FUNCTION	Return the number of the pass/fail monitor which



## Digital Oscilloscopes Series

			can be displayed on the screen.
<a href="#">*RCL</a>	*RCL	SAVE/RECALL	Recalls one of five non-volatile panel setups.
<a href="#">RCPN</a>	RECALL_PANEL	SAVE/RECALL	Recalls a front-panel setup from mass storage.
<a href="#">*RST</a>	*RST	SAVE/RECALL	The *RST command initiates a device reset.
<a href="#">REFS</a>	REF_SET	FUNCTION	Sets the reference waveform and its options.
<a href="#">*SAV</a>	*SAV	SAVE/RECALL	Stores current state in non-volatile internal memory.
<a href="#">SCDP</a>	SCREEN_DUMP	HARD COPY	Causes a screen dump to controller.
<a href="#">SCSV</a>	SCREEN_SAVE	DISPLAY	Controls the automatic screen saver.
<a href="#">*SRE</a>	*SRE	STATUS	Sets the Service Request Enable register (SRE).
<a href="#">*STB?</a>	*STB?	STATUS	Reads the contents of IEEE 488.
<a href="#">STOP</a>	STOP	ACQUISITION	Immediately stops signal acquisition.
<a href="#">STO</a>	STORE	WAVEFORM TRANSFER	Stores a trace in internal memory or mass storage.
<a href="#">STPN</a>	STORE_PANEL	SAVE/RECALL	Stores front-panel setup to mass storage.
<a href="#">STST</a>	STORE_SETUP	WAVEFORM TRANSFER	Controls the way in which traces are stored.
<a href="#">SAST</a>	SAMPLE_STATUS	ACQUISITION	Return the acquisition status of the scope
<a href="#">SARA</a>	SAMPLE_RATE	ACQUISITION	Return the sample rate of the scope
<a href="#">SANU</a>	SAMPLE_NUM	ACQUISITION	Return the number of sampled points available from last acquisition and the trigger position
<a href="#">SET50</a>	SETTO%50	FUNCTION	Sets the trigger level of the trigger source to the centre of the signal amplitude.
<a href="#">SKEW</a>	SKEW	ACQUISITION	Sets the skew of specified trace.
<a href="#">SXSA</a>	SINXX_SAMPLE	ACQUISITION	Sets the type of the interpolation.
<a href="#">TDIV</a>	TIME_DIV	ACQUISITION	Modifies the time base setting.
<a href="#">TMPL</a>	TEMPLATE	WAVEFORM	Produces a complete

## Digital Oscilloscopes Series

		TRANSFER	waveform template copy.
<a href="#">TRA</a>	TRACE	DISPLAY	Enables or disables the display of a trace.
<a href="#">*TRG</a>	*TRG	ACQUISITION	Executes an ARM command.
<a href="#">TRCP</a>	TRIG_COUPLING	ACQUISITION	Sets the coupling mode of the specified trigger source.
<a href="#">TRDL</a>	TRIG_DELAY	ACQUISITION	Sets the time at which the trigger is to occur.
<a href="#">TRLV</a>	TRIG_LEVEL	ACQUISITION	Adjusts the trigger level of the specified trigger source.
<a href="#">TRLV2</a>	TRIG_LEVEL2	ACQUISITION	Adjusts the second trigger level of the specified trigger source.
<a href="#">TRMD</a>	TRIG_MODE	ACQUISITION	The trigger mode.
<a href="#">TRSE</a>	TRIG_SELECT	ACQUISITION	Selects the condition that will trigger acquisition.
<a href="#">TRSL</a>	TRIG_SLOPE	ACQUISITION	Sets the trigger slope of the specified trigger source.
<a href="#">TRWI</a>	TRIG_WINDOW	ACQUISITION	Return relative height of the trigger window
<a href="#">TRPA</a>	TRIG_PATTERN	ACQUISITION	Sets the condition of the pattern trigger
<a href="#">UNIT</a>	UNIT	ACQUISITION	Sets the unit of specified trace.
<a href="#">VPOS</a>	VERT_POSITION	DISPLAY	Adjusts the vertical position of the FFT trace.
<a href="#">VDIV</a>	VOLT_DIV	ACQUISITION	Sets the vertical sensitivity.
<a href="#">VTCL</a>	VERTICAL	ACQUISITION	Controls the vertical position of the slope trigger line.
<a href="#">WF</a>	WAVEFORM	WAVEFORMTRANS	Gets the waveform from the instrument.
<a href="#">WFSU</a>	WAVEFORM_SETUP	WAVEFORMTRANS	Specifies amount of waveform data to go to controller.
<a href="#">WAIT</a>	WAIT	ACQUISITION	Prevents new analysis until current has been completed.
<a href="#">XYDS</a>	XY_DISPLAY	DISPLAY	Enables or disables to display the XY format

---

# Commands & Queries

## **ACQUISITION**

## **ACQUIRE\_WAY,ACQW**

Command /Query

### **DESCRIPTION**

The ACQUIRE\_WAY command specifies the acquisition mode.

The ACQUIRE\_WAY? Query returns the current acquisition mode.

### **COMMAND SYNTAX**

ACQUIRE\_WAY <mode>[,<time>]

<mode> := {SAMPLING,PEAK\_DETECT,AVERAGE,HIGH\_RES }

<time> := {4, 16, 32, 64,128,256,512,etc}

#### **Note:**

- 1.The [HIGH\_RES] option of mode is applicable for SPO models.
- 2.The <time> parameter only can be set with the average acquisition mode. And its options vary with model.

### **QUERY SYNTAX**

ACQUIRE\_WAY?

### **RESPONSE FORMAT**

ACQUIRE\_WAY <mode>[,<time>]

### **EXAMPLE**

The following command sets the acquisition mode to average mode and also sets the average value to 16.

Command message:

ACQW AVERAGE,16

### **RELATED COMMANDS**

AVGA,PDE

## **STATUS**

## **ALL\_STATUS? , ALST?**

Query

### **DESCRIPTION**

The ALL\_STATUS? Query reads and clears the contents of all status registers: STB, ESR, INR, DDR, CMR, EXR and URR except for the MAV bit (bit 6) of the STB register. For an interpretation of the contents of each register, refer to the appropriate status register.

The ALL\_STATUS? Query is useful in a complete overview of the state of the instrument.

### **QUERY SYNTAX**

ALL\_Status?

### **RESPONSE FORMAT**

ALL\_Status  
STB,<value>,ESR,<value>,INR,<value>,DDR  
,<value>,CMR,<value>,  
EXR,<value>,URR,<value>

<value> := 0 to 65535

### **EXAMPLE**

The following instruction reads the contents of all the status registers:

Command message:

ALST?

Response message:

ALST STB, 0, ESR, 52, INR, 5, DDR, 0,  
CMR, 4,  
EXR, 24, URR, 0

### **RELATED COMMANDS**

\*CLS, CMR? , DDR? ,\*ESR? , EXR? ,  
\*STB? , URR?

## ***ACQUISITION***

## **ARM\_ACQUISITION, ARM** Command

### **DESCRIPTION**

The ARM\_ACQUISITION command enables the signal acquisition process by changing the acquisition state (trigger mode) from “stopped” to “single”.

### **COMMAND SYNTAX**

ARM acquisition

### **EXAMPLE**

The following command enables signal acquisition:

Command message:  
ARM

### **RELATED COMMANDS**

STOP, \*TRG, TRIG\_MODE, WAIT

### **ACQUISITION**

### **ATTENUATION, ATTN**

Command /Query

#### **DESCRIPTION**

The ATTENUATION command selects the vertical attenuation factor of the probe. Values of 1, 5, 10, 50, 100, 500, and 1000 may be specified.

The ATTENUATION? Query returns the attenuation factor of the specified channel.

#### **COMMAND SYNTAX**

<channel>: ATTeNuation <attenuation>  
<channel> : = {C1, C2, C3, C4}  
<attenuation>: = {0.1, 0.2, 0.5, 1, 2, 5, 10, 20, 50, 100, 200, 500, 1000, 2000, 5000, 10000}

#### **QUERY SYNTAX**

<channel>: ATTeNuation?

#### **RESPONSE FORMAT**

<channel>: ATTeNuation <attenuation>

#### **EXAMPLE**

The following command sets to 100 the attenuation factor of Channel 1:

Command message:  
C1:ATTN 100

### **MISCELLANEOUS**

### **AUTO\_CALIBRATE, ACAL**

Command /Query

#### **DESCRIPTION**

The AUTO\_CALIBRATE command is used to enable or disable the quick calibration of the instrument.

The quick calibration may be disabled by issuing the command ACAL OFF. Whenever it is convenient, a \*CAL? Query may be issued to fully calibrate the oscilloscope.

The response to the AUTO\_CALIBRATE? Query indicates whether quick-calibration is enabled.

This command is only used in the CFL series of instruments.

#### **COMMAND SYNTAX**

Auto\_CALibrate <state>  
<state> := {ON, OFF}

#### **QUERY SYNTAX**

Auto\_CALibrate?

#### **RESPONSE FORMAT**

Auto\_CALibrate <state>

#### **EXAMPLE**

The following instruction disables quick calibration:

Command message:  
ACAL OFF

#### **RELATED COMMANDS**

\*CAL?

### ***ACQUISITION***

### **AUTO\_SETUP, ASET**

Command

#### **DESCRIPTION**

The AUTO\_SETUP command attempts to identify the waveform type and automatically adjusts controls to produce a usable display of the input signal.

#### **COMMAND SYNTAX**

AUTO\_SETUP

#### **EXAMPLE**

The following command instructs the oscilloscope to perform an auto-setup:  
Command message:  
ASET

#### **RELATED COMMANDS**

AUTTS



## **ACQUISITION**

## **AUTO\_TYPESET, AUTTS**

Command /Query

### **DESCRIPTION**

The AUTO\_TYPESET command selects the specified type of automatically adjusting which is used to display.

### **COMMAND SYNTAX**

AUTO\_TYPESET <type>  
<type> : = {SP,MP,RS,DRP,RC}  
SP means only one period to be displayed, MP means multiple periods to be displayed, RS means the waveform is triggered on the rise side, DRP means the waveform is triggered on the drop side, and RC means to go back to the state before auto set.

### **QUERY SYNTAX**

AUTO\_TYPESET?

### **RESPONSE FORMAT**

AUTO\_TYPESET <type>

### **EXAMPLE**

The following command sets the type of automatic adjustment to multiple periods:

Command message:

AUTTS MP

### **RELATED COMMANDS**

ASET

**ACQUISITION**

**AVERAGE\_ACQUIRE, AVGA**

Command /Query

**DESCRIPTION**

The AVERAGE\_ACQUIRE command selects the average times of average acquisition.

The response to the AVERAGE\_ACQUIRE query indicates the times of average acquisition.

**COMMAND SYNTAX**

AVERAGE\_ACQUIRE <time>

<time> : = {4, 16, 32, 64,128,256,etc}

**Note:**

The <time> parameter's options vary with model.

**QUERY SYNTAX**

AVERAGE\_ACQUIRE?

**RESPONSE FORMAT**

AVERAGE\_ACQUIRE <time>

**EXAMPLE**

The following turns the average times of average acquisition 16:

Command message:

AVGA 16

**ACQUISITION**

**BANDWIDTH\_LIMIT, BWL**

Command /Query

**DESCRIPTION**

BANDWIDTH\_LIMIT enables or disables the bandwidth-limiting low-pass filter. If the bandwidth filters are on, it will limit the bandwidth to reduce display noise. When you turn Bandwidth Limit ON, the Bandwidth Limit value is set to 20 MHz. It also filters the signal to reduce noise and other unwanted high frequency components.

The response to the BANDWIDTH\_LIMIT? Query indicates whether the bandwidth filters are on or off.

**COMMAND SYNTAX**

BandWidth\_Limit <channel>, <mode>  
[, <channel>, <mode> [, <channel>, <mode>  
[, <channel>, <mode>]]]

<channel> := {C1, C2, C3, C4}

<mode>:= {ON, OFF}

**QUERY SYNTAX**

BandWidth\_Limit?

**RESPONSE FORMAT**

BandWidth\_Limit <channel>, <mode>  
[,<channel>,<mode> [, <channel>, <mode> [,  
<channel>,<mode>]]]

**EXAMPLE**

The following turns on the bandwidth filter for all channels, when Global\_BWL is on (as it is by default)

The following turns the bandwidth filter on for Channel 1only:

Command message:  
BWL C1, ON

**MISCELLANEOUS**

**BUZZER, BUZZ**

Command /Query

**DESCRIPTION**

The BUZZER command enables or disables sounds for keypresses and other functions.

The response to the BUZZER? query indicates whether the sound switch is enabled or not.

**COMMAND SYNTAX**

BUZZer <state>  
<state>: = {ON, OFF}

**QUERY SYNTAX**

BUZZER?

**RESPONSE FORMAT**

BUZZER <state>

**EXAMPLE**

Sending the following code will enable the oscilloscope sound.

Command message:  
BUZZ ON

**MISCELLANEOUS**

**\*CAL?**  
Query

**DESCRIPTION**

The \*CAL? query causes the oscilloscope to perform an internal self-calibration and generates a response.

**QUERY SYNTAX**

\*CAL?

**RESPONSE FORMAT**

\*CAL <diagnostics>  
<diagnostics> : = 0  
0 = Calibration successful

**EXAMPLE**

The following instruction forces a self-calibration:

Command message:

\*CAL?

Response message:

\*CAL 0

**RELATED COMMANDS**

AUTO\_CALIBRATE

**COMMUNICATION****COMM\_HEADER, CHDR**

Command/ Query

**DESCRIPTION**

The COMM\_HEADER command controls the way the oscilloscope formats responses to queries. There are three response formats: LONG, in which responses start with the long form of the header word; SHORT, where responses start with the short form of the header word; and OFF, for which headers are omitted from the response and units in numbers are suppressed.

Unless you request otherwise, the SHORT response format is used.

This command does not affect the interpretation of messages sent to the oscilloscope. Headers can be sent in their long or short form regardless of the COMM\_HEADER setting.

Querying the vertical sensitivity of Channel 1 may result in one of the following responses:

COMM_HEADER	RESPONSE
LONG	C1:VOLT_DIV 200E-3 V
SHORT	C1:VDIV 200E-3 V
OFF	200E-3

**COMMAND SYNTAX**

Comm\_HeaDeR <mode>  
<mode> := {SHORT, LONG, OFF}

**QUERY SYNTAX**

Comm\_HeaDeR?

**RESPONSE FORMAT**

Comm\_HeaDeR <mode>

**EXAMPLE**

The following code sets the response header format to SHORT:

Command message:  
CHDR SHORT

### ***STATUS***

**\*CLS**  
Command

#### **DESCRIPTION**

The \*CLS command clears all the status data registers.

#### **COMMAND SYNTAX**

\*CLS

#### **EXAMPLE**

The following command causes all the status data registers to be cleared:

Command message:

\*CLS

#### **RELATED COMMANDS**

ALL\_STATUS, CMR, DDR, \*ESR, EXR, \*STB, URR

**STATUS**

**CMR?**

Query

**DESCRIPTION**

The CMR? Query reads and clears the contents of the Command error Register (CMR) — see table next page—which specifies the last syntax error type detected by the instrument.

**QUERY SYNTAX  
RESPONSE FORMAT**

CMR?  
CMR <value>  
<value> : = 0 to 14

**EXAMPLE**

The following instruction reads the contents of the CMR register:

Command message:  
CMR?

Response message:  
CMR 0

**RELATED COMMANDS**

ALL\_STATUS? ,\*CLS

**ADDITIONAL INFORMATION**

Command Error Status Register Structure (CMR)	
Value	Description
1	Unrecognized command/query header
2	Invalid character
3	Invalid separator
4	Missing parameter
5	Unrecognized keyword
6	String error
7	Parameter cannot allowed
8	Command String Too Long
9	Query cannot allowed
10	Missing Query mask
11	Invalid parameter
12	Parameter syntax error
13	Filename too long



### **MISCELLANEOUS**

### **COMM\_NET, CONET**

Command /Query

#### **DESCRIPTION**

The COMM\_NET command changes the IP address of the oscilloscope's internal network interface.

The COMM\_NET? query returns the IP address of the oscilloscope's internal network interface.

#### **COMMAND SYNTAX**

COMM\_NET <ip\_add0>, <ip\_add1>, <ip\_add2>,  
<ip\_add3>  
< ip\_add >:= 0 to 255

#### **QUERY SYNTAX**

COMM\_NET?

#### **RESPONSE FORMAT**

COMM\_NET <ip\_add0>, <ip\_add1>, <ip\_add2>,  
<ip\_add3>

#### **EXAMPLE**

This instruction will change the IP address to 10.11.0.230:

Command message:  
CONET 10,11,0,230

### **FUNCTION**

### **COUNTER,COUN**

Command /Query

### **DESCRIPTION**

The COUNTER command enables or disables the cymometer display on the screen of instrument.

The response to the COUNTER? query indicates whether the cymometer is displayed on the screen of instrument.

### **COMMAND SYNTAX**

COUNTER <state>

< state > : = {ON, OFF}

### **QUERY SYNTAX**

COUNTER?

### **RESPONSE FORMAT**

COUNTER <state>

### **EXAMPLE**

The following command enables the cymometer display

Command message:  
COUN ON

#### **Note:**

This command is suitable for non-SPO models.

### **ACQUISITION**

### **COUPLING, CPL**

Command /Query

#### **DESCRIPTION**

The COUPLING command selects the coupling mode of the specified input channel.

The COUPLING? query returns the coupling mode of the specified channel.

#### **COMMAND SYNTAX**

<channel>: CouPLing <coupling>

<channel> := {C1, C2, C3, C4}

<coupling> := {A1M, A50, D1M, D50, GND}

The A of the <coupling> is alternating current. The D of the <coupling> is direct current. 1M and 50 is the impedance of input. Some series (CML) couldn't have the set of input impedance.

#### **Note:**

The options of <coupling> vary with models. If your oscilloscope is an SPO model, the options are {A1M, A50, D1M, D50, GND}, otherwise the options are {A1M, D1M, GND}.

#### **QUERY SYNTAX**

<channel>: CouPLing?

#### **RESPONSE FORMAT**

<channel>: CouPLing <coupling>

#### **EXAMPLE**

The following command sets the coupling of Channel 2 to 50  $\Omega$ DC:

Command message:

C2: CPL D50

### ***CURSOR***

### **CURSOR\_AUTO,CRAU**

Command

#### **DESCRIPTION**

The CURSOR\_AUTO command changes the cursor mode to auto mode.

#### **COMMAND SYNTAX**

CRAU

#### **EXAMPLE**

The following code changes the cursor mode to auto mode

Command message:  
CRAU

#### **Note:**

This command is suitable for non-SPO models.

## **CURSOR**

## **CURSOR\_MEASURE, CRMS**

Command /Query

### **DESCRIPTION**

The CURSOR\_MEASURE command specifies the type of cursor or parameter measurement to be displayed

The CURSOR\_MEASURE? query indicates which cursors or parameter measurements are currently displayed.

### **COMMAND SYNTAX**

CuRsr\_MeaSure <mode>

Format 1:

<mode>::{OFF, ON}

Format 2:

<mode>::{OFF, HREL, VREL, AUTO}

#### **Note:**

- 1.If the oscilloscope doesn't have auto cursor, you should use format 1. OFF means manual mode, ON means track mode.
- 2.If the oscilloscope doesn't have auto cursor, you should use format 2. HREL means track mode, VREL means manual mode, AUTO means auto mode.

### **QUERY SYNTAX**

CuRsr\_MeaSure?

### **RESPONSE FORMAT**

CuRsr\_MeaSure <mode>

### **EXAMPLE**

The following command determines cursor function is turned off:

Command message:

CRMS OFF

### **RELATED COMMANDS**

CURSOR\_VALUE, PARAMETER\_VALUE

**CURSOR**

**CURSOR\_SET, CRST**

Command /Query

**DESCRIPTION**

The CURSOR\_SET command allows the user to position any one of the eight independent cursors at a given screen location. The positions of the cursors can be modified or queried even if the required cursor is not currently displayed on the screen. When setting a cursor position, a trace must be specified, relative to which the cursor will be positioned.

The CURSOR\_SET? Query indicates the current position of the cursor(s). The values returned depend on the grid type selected.

Notation	
VREF	The voltage-value of curA under manual cursor mode
VDIF	The time value of curA under manual cursor mode
TREF	The time value of curB under manual cursor mode
TDIF	The time value of curB under manual cursor mode
HRDF	The time value of curA under Track cursor mode
HDIF	The time value of curB under Track cursor mode

**COMMAND SYNTAX**

```

<trace>:CuRsor_SeT<cursor>,<position>[,<cursor
>,<position>,<cursor> ,<position>]
    
```

< trace > : = {C1, C2, C3, C4}

<cursor> : =

{ VREF,VDIF,TREF,TDIF,HRDF,HDIF}

<position>(horizontal): = {0.02 to 13.98 DIV }

<position>(vertical): = {0.02 to 7.98 DIV }

**Note:**

1. The horizontal position's value is related to the size of screen. For SPO models, the position's value is in the range of 0.02 to 13.98. And in non-SPO models it's in the range of -8 to 8. If the value is in the range of 0.02 to 13.98, you need

add the unit (DIV) to the value.

2. The vertical position's value is related to the size of screen. For SPO models, the position's value is in the range of 0.02 to 7.98. And in non-SPO models it's in the range of -4 to 4. If the value is in the range of 0.02 to 7.98, you need add the unit (DIV) to the value.

### QUERY SYNTAX

```
<trace>: CuRsr_SeT? [<cursor>, ...<cursor>]  
<cursor> :=  
{ VREF,VDIF,TREF,TDIF,HRDF,HDIF}
```

### RESPONSE FORMAT

```
<trace>:CuRsr_SeT <cursor>, <position> [,  
<cursor>, <position>, <cursor>, <position>]
```

### EXAMPLE

The following command positions the VREF and VDIF cursors at +3 DIV and -1 DIV respectively, using C1 as a reference:

Command message:

```
C1: CRST VREF, 3DIV, VDIF, -1DIV
```

### RELATED COMMANDS

```
CURSOR_MEASURE,CURSOR_VALUE,  
PARAMETER_VALUE
```

**CURSOR**

**CURSOR\_VALUE?, CRVA?**

Query

**DESCRIPTION**

The CURSOR\_VALUE? Query returns the values measured by the specified cursors for a given trace. (The PARAMETER\_VALUE? query is used to obtain measured waveform parameter values.)

Notation	
HREL	the cursor value under track cursor mode
VREL	the delta volt-value, curA volt_value and curB volt_value under manual cursor mode

**Note:**

For non-SPO models , VREL is the delta volt-value under manual cursor mode.

**QUERY SYNTAX**

```
<trace>: CuRsr_ Value? [<mode>,...<mode>]
<trace> := { C1, C2, C3, C4}
<mode> := { HREL, VREL }
```

**RESPONSE FORMAT**

```
<trace> : CuRsr_ Value HREL,
<delta_hori>,<delta_vert>,<A->T>,
<A->V>,<(delta_vert)/(delta_hori)>
<trace> : CuRsr_ Value VREL,<delta_vert>
```

**EXAMPLE**

The following query reads the delta volt value under manual cursor mode (VREL) on Channel 2:

Command message:

C2:CRVA? VREL

Response message:

C2:CuRsr\_ Value VREL 1.00V

**RELATED COMMANDS**

CURSOR\_SET, PARAMETER\_VALUE



### **SAVE/RECALL**

### **CSV\_SAVE, CSVS**

Command /Query

#### **DESCRIPTION**

The CSV\_SAVE command selects the specified option of storing CSV format waveform.

The CSV\_SAVE? query returns the option of storing waveform data of CSV format.

#### **COMMAND SYNTAX**

Format1:

CSV\_SAVE SAVE,<state>

The option SAVE is that if the waveform data is stored with parameter.

<save>: = {OFF, ON}

Format2:

CSV\_SAVE DD,<DD>,SAVE,<state>

The option DD is the data depth which is saved as. The option SAVE is that if the waveform data is stored with parameter.

<DD>: = {MAX, DIS} the meaning of MAX is saved as the maximum data depth. The meaning of DIS is saved as the data depth which is displayed on the screen

<save>: = {OFF, ON}

#### **Note:**

This command varies with models, so there are two formats. If your oscilloscope can set the data depth of CSV file which will be saved, you should use Format2, such as non-SPO models, otherwise you should use Format1.

#### **QUERY SYNTAX**

CSV\_SAVE?

#### **RESPONSE FORMAT**

CSV\_SAVE SAVE, <state>

#### **EXAMPLE**

The following command sets "para" save to off  
Command message:

Format1:

CSV\_SAVE SAVE,OFF

Format2:

CSVS DD,DIS,SAVE,OFF

**FUNCTION**

**CYMOMETER, CYMT**

Query

**DESCRIPTION**

The response to the CYMOMETER? query is the value of cymometer which displaying on the screen of the instrument. When the signal frequency is less than 10Hz, it returns 10Hz.

**QUERY SYNTAX**

CYMOMETER?

**RESPONSE FORMAT**

CYMOMETER <option>

**EXAMPLE**

The following instruction returns the value of cymometer which displaying on the screen of the instrument.

Response message:  
CYMT 10Hz

### **MISCELLANEOUS**

### **DATE**

Command /Query

#### **DESCRIPTION**

The DATE command changes the date/time of the oscilloscope's internal real-time clock.

The command is only used in the CFL series instrument.

#### **COMMAND SYNTAX**

DATE <day>, <month>, <year>, <hour>,  
<minute>, <second>

<day> : = 1 to 31

<month> : = {JAN, FEB, MAR, APR, MAY, JUN,  
JUL, AUG, SEP, OCT, NOV, DEC}

<year> : = 1990 to 2089

<hour> : = 0 to 23

<minute> : = 0 to 59

<second> : = 0 to 59

#### **QUERY SYNTAX**

DATE?

#### **RESPONSE FORMAT**

DATE <day>, <month>, <year>, <hour>,  
<minute>, <second>

#### **EXAMPLE**

This instruction will change the date to  
NOV. 1, 2009 and the time to 14:38:16:

Command message:

DATE 1, NOV, 2009,14,38,16

### **STATUS**

### **DDR?**

Query

#### **DESCRIPTION**

The DDR? Query reads and clears the contents of the Device Dependent or device specific error Register (DDR). In the case of a hardware failure, the DDR register specifies the origin of the failure.

#### **QUERY SYNTAX**

DDR?

#### **RESPONSE FORMAT**

DDR <value>  
<value> : = 0 to 65535

#### **EXAMPLE**

The following instruction reads the contents of the DDR register:

Command message:  
DDR?

Response message:  
DDR 0

#### **RELATED COMMANDS**

ALL\_STATUS? ,\*CLS

### **FUNCTION**

### **DEFINE, DEF**

Command /Query

#### **DESCRIPTION**

The DEFINE command specifies the mathematical expression to be evaluated by a function.

#### **COMMAND SYNTAX**

DEFine EQN,'<equation>'

#### **Note:**

<equation> is the mathematical expression

Function Equations	
<source1> + <source2>	Addition
<source1> - <source2>	Subtraction
<source1>*<source2>	Multiplication
<source1>/<source2>	Ratio
FFT(source x)	FFT
INTG(source x)	Integral
DIFF(source x)	Differentiator
SQRT(source x)	Square Root

#### **QUERY SYNTAX**

DEFine?

#### **RESPONSE FORMAT**

DEFine EQN,'<equation>'

#### **EXAMPLE**

Command message:

DEFine EQN,'C1\*C2'

### **MASS STORAGE**

### **DELETE\_FILE,DEL**

**Command**

#### **DESCRIPTION**

The DELETE\_FILE command deletes files from the currently selected directory on mass storage.

#### **COMMAND SYNTAX**

DELEte\_File DISK, <device>, FILE,  
'<filename>'

<device>: ={UDSK}

<filename>: = a file of specified directory and the specified file should up to eight characters.

#### **EXAMPLE**

The following command deletes a front-panel setup from the directory named SETUP in a USB memory device:

Command message:

```
DELf DISK, UDSK, FILE, '/ SETUP  
/001.SET'
```

#### **RELATED COMMANDS**

DIRECTORY

**MASS STORAGE****DIRECTORY, DIR**

Command /Query

**DESCRIPTION**

The DIRECTORY command is used to manage the creation and deletion of file directories on mass storage devices. It also allows selection of the current working directory and listing of files in the directory.

The query response consists of a double-quoted string containing a DOS-like listing of the directory.

**COMMAND SYNTAX**

Directory DISK, <device>, ACTION, <action>, '<directory>'

**QUERY SYNTAX**

Directory? DISK, <device> [, '<directory>']

<device>: = {UDSK}

<action>: = {CREATE, DELETE}

< directory >: = A legal DOS path or filename. (This can include the '/' character to define the root directory.)

**RESPONSE FORMAT**

DIRectory DISK, <device> "<directory>"

**EXAMPLE**

The following asks for a listing of the directory of a USB memory device:

Command message:

DIR? DISK, UDSK

Response message:

DIRectory DISK, UDSK, "A:

SDS1000X

BB.SET 2.00 KB

SDS00001.SET 2.00 KB

SDS00002.SET 2.00 KB

3 File(s), 2 DIR(s)

**RELATED COMMANDS**

DELF

**DISPLAY**

**DOT\_JOIN,DTJN**

Command /Query

**DESCRIPTION**

The DOT\_JOIN command controls the interpolation lines between data points.

**COMMAND SYNTAX**

DoT\_JoiN <state>  
<state> := {ON, OFF}

**QUERY SYNTAX**

DoT\_JoiN?

**RESPONSE FORMAT**

DoT\_JoiN <state>

**EXAMPLE**

The following instruction turns off the interpolation lines:

Command message:  
DTJN OFF



### ***STATUS***

### **\*ESE**

Command /Query

#### **DESCRIPTION**

The \*ESE command sets the Standard Event Status Enable register (ESE). This command allows one or more events in the ESR register to be reflected in the ESB summary message bit (bit 5) of the STB register.

#### **COMMAND SYNTAX**

\*ESE <value>  
<value> : = 0 to 255

#### **QUERY SYNTAX**

\*ESE?

#### **RESPONSE FORMAT**

\*ESE <value>

#### **EXAMPLE**

The following instruction allows the ESB bit to be set if a user request (URQ bit 6, i.e. decimal 64) and/or a device dependent error (DDE bit 3, i.e. decimal 8) occurs. Summing these values yields the ESE register mask  $64+8=72$ .

Command message:

\*ESE 72

#### **RELATED COMMANDS**

\*ESR

### **STATUS**

### **\*ESR?**

Command /Query

#### **DESCRIPTION**

The \*ESR? query reads and clears the contents of the Event Status Register (ESR). The response represents the sum of the binary values of the register bits 0 to 7.

#### **QUERY SYNTAX**

\*ESR?

#### **RESPONSE FORMAT**

\*ESER<value>  
<value> : = 0 to 255

#### **EXAMPLE**

The following instruction reads and clears the contents of the ESR register:

Command message:

\*ESR?

Response message:

\*ESR 0

#### **RELATED COMMANDS**

ALL\_STATUS, \*CLS, \*ESE

### **ADDITIONAL INFORMATION**

<b>Standard Event Status Register (ESR)</b>					
Bit	Bit Value	Bit Name	Description		Note
15~8			0	reserved by IEEE 488.2	
7	128	PON	1	Power off-to-ON transition as occurred	(1)
6	64	URQ	1	User Request has been issued	(2)
5	32	CME	1	Command parser Error has been detected	(3)
4	16	EXE	1	Execution Error detected	(4)
3	8	DDE	1	Device specific Error occurred	(5)
2	4	QYE	1	Query Error occurred	(6)
1	2	RQC	1	Instrument never requests bus control	(7)
0	1	OPC	1	Instrument never requests bus control	(8)

### Notes

- (1) The Power On (PON) bit is always turned on (1) when the unit is powered up.
- (2) The User Request (URQ) bit is set true (1) when a soft key is pressed. An associated register URR identifies which key was selected. For further details refer to the URR? query.
- (3) The CoMmand parser Error bit (CME) is set true (1) whenever a command syntax error is detected. The CME bit has an associated CoMmand parser Register (CMR) which specifies the error code. Refer to the query CMR? for further details.
- (4) The EXecution Error bit (EXE) is set true (1) when a command cannot be executed due to some device condition (e.g. oscilloscope in local state) or a semantic error. The EXE bit has an associated Execution Error Register (EXR) which specifies the error code. Refer to query EXR? for further details.
- (5) The Device specific Error (DDE) is set true (1) whenever a hardware failure has occurred at power-up, or execution time, such as a channel overload condition, a trigger or a timebase circuit defect. The origin of the failure may be localized via the DDR? or the self test \*TST? query.
- (6) The Query Error bit (QYE) is set true (1) whenever (a) an attempt is made to read data from the Output Queue when no output is either present or pending, (b) data in the Output Queue has been lost, (c) both output and input buffers are full (deadlock state), (d) an attempt is made by the controller to read before having sent an <END>, (e) a command is received before the response to the previous query was read (output buffer flushed).
- (7) The ReQuest Control bit (RQC) is always false (0), as the oscilloscope has no GPIB controlling capability.
- (8) The OPeration Complete bit (OPC) is set true (1) whenever \*OPC has been received, since commands and queries are strictly executed in sequential order. The oscilloscope starts processing a command only when the previous command has been entirely executed.

### **STATUS**

### **EXR?**

Query

#### **DESCRIPTION**

The EXR? query reads and clears the contents of the Execution error Register (EXR). The EXR register specifies the type of the last error detected during execution.

#### **QUERY SYNTAX**

EXR?

#### **RESPONSE FORMAT**

EXR <value>  
<value> := to

#### **EXAMPLE**

The following instruction reads the contents of the EXR register:

Command message:  
EXR?

Response message (if no fault):  
EXR 0

#### **RELATED COMMANDS**

ALL\_STATUS, \*CLS

### **ADDITIONAL INFORMATION**

<b>Execution Error Status Register Structure (EXR)</b>	
Value	Description
21	Permission error. The command cannot be executed in local mode.
22	Environment error. The instrument is not configured to correctly process a command. For instance, the oscilloscope cannot be set to RIS at a slow timebase.
23	Option error. The command applies to an option which has not been installed.
25	Parameter error. Too many parameters specified.
26	Non-implemented command.
32	Waveform descriptor error. An invalid waveform descriptor has been detected.
36	Panel setup error. An invalid panel setup data block has been detected.
50	No mass storage present when user attempted to access it.
53	Mass storage was write protected when user attempted to create, or a file, to delete a file, or to format the device.
58	Mass storage file not found.
59	Requested directory not found.
61	Mass storage filename not DOS compatible, or illegal filename.
62	Cannot write on mass storage because filename already exists.

**MASS STORAGE****FILENAME, FLNM**

Command /Query

**DESCRIPTION**

The FILENAME command is used to change the default filename given to any traces, setups and hard copies when they are being stored to a mass storage device.

**COMMAND SYNTAX**

FiLeNaMe TYPE, <type>, FILE, '<filename>'  
<type>:={ C1,C2,C3, C4, SETUP,TA, TB, TC, TD, HCOPIY}  
<filename> : = an alphanumeric string of up to 8 characters forming a legal DOS filename.

**Note:**

The file's extension can be specified automatically by the oscilloscope.

**QUERY SYNTAX**

FiLeNaMe? TYPE, <type>  
<type> :={ ALL, C1, C2, C3, C4, SETUP, TA, TB, TC, TD, HCOPIY}

**RESPONSE FORMAT**

FiLeNaMe TYPE, <type>, FILE, "<filename>"  
[,TYPE, <type>, FILE, "<filename>"...]

**EXAMPLE**

The following command designates channel 1 waveform files to be "TESTWF.DAV":

Command message:

FLNM TYPE, C1, FILE, 'TESTWF'

**RELATED COMMANDS**

DIRECTORY, DELETE\_FILE

**MASS STORAGE**

**FRAME\_PARAM, FPAR**  
Query

**DESCRIPTION**

The FRAME\_PARAM command is used to get frame param include descriptor name, product name, the total number of frames and so on.

**QUERY SYNTAX**

FPAR?

**Note:** This command is used with the history function.

**RESPONSE FORMAT**

The format of the response is binary.

**EXAMPLE**

The following command gets the frame parameters:

Command message:  
FPAR?

### **MASS STORAGE**

### **FRAME\_SET, FRAM**

Command

#### **DESCRIPTION**

The FRAME\_SET command is used to set history current frame number.

#### **COMMAND SYNTAX**

FRAM <frame\_num>

Frame\_num = 0 to the max frame number

**Note:** This command is used with the history function.

#### **EXAMPLE**

The following command sets current frame number to 50:

Command message:  
FRAM 50

**ACQUISITION**

**FORCE\_TRIGGER,FRTR**

Command

**DESCRIPTION**

Causes the instrument to make one acquisition.

**COMMAND SYNTAX**

Force\_TriGger

**EXAMPLE**

Either of the following pairs of instructions make one acquisition:

Command message1:

TRMD SINGLE;ARM;FRTR

Command message2:

TRMD STOP;ARM;FRTR



**MASS STORAGE**

**FRAME\_TIME, FTIM**

Query

**DESCRIPTION**

The FRAME\_TIME command is used to get current frame Acq. Time.

**QUERY SYNTAX**

FTIM?

**Note:** This command is used in history function opening.

**RESPONSE FORMAT**

The format of response is binary.

**EXAMPLE**

The following query reads the current frame Acq.Time.

Command message:

FTIM?

**MASS STORAGE**

**FORMAT\_VDISK, FVDISK**

Query

**DESCRIPTION**

The FORMAT\_VDISK? query reads the capability of the USB memory device.

**QUERY SYNTAX**

Format\_VDISK?

**RESPONSE FORMAT**

Format\_VDISK <capability>  
<capability>:= the capability of the USB memory device.

**EXAMPLE**

The following query reads the capability of the USB device.

Command message:

Format\_VDISK?

Response message:

Format\_VDISK 963 MB

**FUNCTION**

**FFT\_WINDOW, FFTW**

Command /Query

**DESCRIPTION**

The FFT\_WINDOW command selects the window of FFT(Fast Fourier Transform algorithm).

The response to the FFT\_WINDOW? query indicates current window of FFT

**COMMAND SYNTAX**

FFT\_WINDOW <window>  
<window > := {RECT,BLAC,HANN,HAMM}  
RECT is short for rectangle.  
BLAC is short for Blackman.  
HANN is short for hanning.  
HAMM is short for hamming

**QUERY SYNTAX**

FFT\_WINDOW?

**RESPONSE FORMAT**

FFT\_WINDOW,<window>

**EXAMPLE**

The following command sets the FFT window to hamming:

Command message:  
FTW HAMM

### ***FUNCTION***

### **FFT\_ZOOM,FFTZ**

Command /Query

### **DESCRIPTION**

The FFT\_ZOOM command selects the specified zoom of FFT.

The response to the FFT\_ZOOM? query indicates current zoom in/out of FFT.

### **COMMAND SYNTAX**

FFT\_ZOOM <zoom>  
< zoom > : = {1,2,5,10}

### **QUERY SYNTAX**

FFT\_ZOOM?

### **RESPONSE FORMAT**

FFT\_ZOOM,<zoom>

### **EXAMPLE**

The following command sets the zoom factor of FFT to 1X:

Command message:  
FFTZ 1

### ***FUNCTION***

### **FFT\_SCALE,FFTS**

Command /Query

#### **DESCRIPTION**

The FFT\_SCALE command selects the specified scale of FFT (Fast Fourier Transform algorithm).

The response to the FFT\_SCALE? query indicates current vertical scale of FFT waveform.

#### **COMMAND SYNTAX**

FFT\_SCALE <scale>  
< scale > : = {VRMS,DBVRMS}

#### **QUERY SYNTAX**

FFT\_SCALE?

#### **RESPONSE FORMAT**

FFT\_SCALE,< scale >

#### **EXAMPLE**

The following command turns the vertical scale of FFT to dBVrms:

Command message:  
FFTS DBVRMS

**FUNCTION**

**FFT\_FULLSCREEN,FFTF**

Command /Query

**DESCRIPTION**

The FFT\_FULLSCREEN command enables or disables to display the FFT waveform full screen.

The response to the FFT\_FULLSCREEN? query indicates whether the FFT waveform is full screen displayed.

**COMMAND SYNTAX**

FFT\_FULLSCREEN <state>  
< state > := {ON,OFF}

**QUERY SYNTAX**

FFT\_FULLSCREEN?

**RESPONSE FORMAT**

FFT\_FULLSCREEN < state >

**EXAMPLE**

The following command enables to display the FFT waveform full screen:

Command message:  
FFTF ON

### **FUNCTION**

### **FILTER,FILT**

Command /Query

### **DESCRIPTION**

The FILTER command enables or disables filter of the specified trace.

The response to the FILTER? query indicates whether the filter of specified trace is enabled.

### **COMMAND SYNTAX**

```
<channel>:FILTER <state>  
<channel> := {C1,C2,C3,C4}  
<state> := {ON,OFF}
```

### **QUERY SYNTAX**

```
<channel>:FILTER?
```

### **RESPONSE FORMAT**

```
<channel>:FILTER <state>
```

### **EXAMPLE**

The following command enables the filter of channel 1:

```
Command message:  
C1:FILT ON
```

### **RELATED COMMANDS**

FILTS

#### **Note:**

This command is suitable for non-SPO models.

### **FUNCTION**

### **FILT\_SET,FILTS**

Command /Query

### **DESCRIPTION**

The FILT\_SET command selects the specified type of filter, and sets the limit value of filter.

The response to the FILT\_SET? query indicates current parameter of the filter.

### **COMMAND SYNTAX**

```
<channel>:FILT_SET  
TYPE,<type>,<limit>,<limit_value>  
<channel> := {C1,C2,C3,C4}  
<type> := {LP,HP,BP,BR}  
<limit> := {UPPLIMIT,LOWLIMIT}
```

**Note:**

1. LP is low-pass, HP is high-pass, BP is band-pass, BR is band-reject.
2. If seted the <limit>, the <type> must be related.

### **QUERY SYNTAX**

```
<channel>: FILT_SET?
```

### **RESPONSE FORMAT**

```
<channel>:FILTER TYPE,<type>,<limit>,<limit_value >
```

### **EXAMPLE**

The following command changes the type of filter to band-pass, and sets the up-limit to 200 KHz and the low-limit to 100 KHz:

```
Command message:  
C1:FILTS TYPE,BP,  
UPPLIMIT,200KHz,LOWLIMIT,100KHz
```

### **RELATED COMMANDS**

FILT

**Note:**

This command is suitable for non-SPO models.



**DISPLAY**

**GRID\_DISPLAY,GRDS**

Command /Query

**DESCRIPTION**

The GRID\_DISPLAY command selects the type of the grid which is used to display.

The response to the GRID\_DISPLAY? query indicates current type of the grid.

**COMMAND SYNTAX**

GRID\_DISPLAY <type>  
< type > := {FULL,HALF,OFF}

**QUERY SYNTAX**

GRID\_DISPLAY?

**RESPONSE FORMAT**

GRID\_DISPLAY < type >

**EXAMPLE**

The following command changes the type of grid to full grid:

Command message:  
GRID\_DISPLAY FULL

### **WAVEFORMTRANS**

### **GET\_CSV,GCSV**

Query

#### **DESCRIPTION**

The response to the GET\_CSV? Query indicates current waveform of CSV format.

The GET\_CSV? query has options to set. They are the same as the options of CSVS.

#### **QUERY SYNTAX**

Format1:

GET\_CSV? SAVE,<state>

The option SAVE sets the CSV save state.

<state>: = {OFF,ON}

Format2:

GET\_CSV? DD,<DD>,,SAVE,<state>

The option DD is the data depth of the CSV format waveform.

The option SAVE sets the CSV save state.

<DD>: = {MAX, DIS}

MAX sets the CSV waveform depth to maximum.

DIS sets the CSV waveform depth equal to the displayed on the screen.

<state>: = {OFF,ON}

#### **Note:**

This command varies with models, so there are two formats. If you oscilloscope can set the data depth of CSV file which will be saved, you should use Format 2, otherwise you should use Format 1.

#### **RESPONSE FORMAT**

The waveform data of CSV format

#### **EXAMPLE**

The following command transfers the waveform data of CSV format to the controller. It has parameter information.

Command message:

Foramt1:

GET\_CSV? SAVE,ON

Foramt2:

GET\_CSV? DD,DIS,SAVE,ON

**DISPLAY****HOR\_MAGNIFY, HMAG**

Command /Query

**DESCRIPTION**

The HOR\_MAGNIFY command horizontally expands the selected expansion trace by a specified factor. Magnification factors not within the range of permissible values will be rounded off to the closest legal value.

If the specified factor is too large for any of the expanded traces (depending on their current source), it is reduced to an acceptable value and only then applied to the traces. The VAB bit (bit 2) in the STB register is set when a factor outside the legal range is specified.

The HOR\_MAGNIFY query returns the current magnification factor for the specified expansion function.

**COMMAND SYNTAX**

<exp\_trace>: Hor\_MAGnify <factor>  
<exp\_trace>: = {TA, TB, TC, TD}  
<factor> : = 1 to 2,000,000 The range of <factor> is related to the current timebase and the range of the timebase.

**QUERY SYNTAX**

<exp\_trace> : Hor\_MAGnify?

**RESPONSE FORMAT**

<exp\_trace>: Hor\_MAGnify <factor>

**EXAMPLE**

The following instruction horizontally magnifies Trace A (TA) by a factor of 5:

Command message:  
TA: HMAG 5.00

**RELATED COMMANDS**

HPOS

**DISPLAY****HOR\_POSITION, HPOS**

Command /Query

**DESCRIPTION**

The HOR\_POSITION command horizontally positions the geometric center of the intensified zone on the source trace. Allowed positions range from division -7 to 7. If this would cause the horizontal position of any expanded trace to go outside the left or right screen boundaries, the difference of positions is adapted and then applied to the traces.

The VAB bit (bit 2) in the STB register is set if a value outside the legal range is specified.

The HOR\_POSITION query returns the position of the geometric center of the intensified zone on the source trace.

**COMMAND SYNTAX**

```
<exp_trace>: Hor_POSition <hor_position>
<exp_trace>: = {TA, TB, TC, TD}
<hor_position>: = -7 to 7 DIV
```

The range of the value is related to the size of the screen. The range of the <hor\_position> is related to the magnification factors of command HMAG. While the range after magnifying beyond the screen could display, it will be adjusted to the proper value.

**QUERY SYNTAX**

```
<exp_trace>: Hor_POSition?
```

**RESPONSE FORMAT**

```
<exp_trace>: Hor_POSition <hor_position>
```

**EXAMPLE**

The following instruction positions the center of the intensified zone on the trace currently viewed by Trace A (TA) at division 3:

```
Command message:
TA: HPOS 3
```

**RELATED COMMANDS**

```
HMAG
```

**HARD COPY**

**HARDCOPY\_SETUP, HCSU**

Command /Query

**DESCRIPTION**

The HARDCOPY\_SETUP command configures the instrument's hard-copy driver.

**COMMAND SYNTAX**

HCSU PSIZE, <page\_size>,  
ISIZE, <image\_size>,  
FORMAT, <format>, BCKG,  
<bckg>, PRTKEY, <printkey>

<page\_size> := { DEFAULT }  
<printkey> := { SAVE, PRINT }  
<format> := { PORTRAIT, LANDSCAPE }  
<bckg> := { BLACK, WHITE }  
<image\_size> := { DEFAULT, A4, LETTER }.

**QUERY SYNTAX**

HCSU?

**RESPONSE FORMAT**

HCSU PSIZE, <page\_size>, ISIZE, <image\_size>,  
FORMAT, <format>, BCKG, <bckg>, PRTKEY,  
<printkey>

**EXAMPLE**

The following example selects PORTRAIT format, sets the size of the image to "6\*8CM":

Command message:

HCSU ISIZE, 6\*8CM, FORMAT, PORTRAIT

**RELATED COMMANDS**

SCDP

### **MISCELLANEOUS**

### **\*IDN?** Query

#### **DESCRIPTION**

The \*IDN? query is used for identification purposes. The response consists of four different fields providing information on the manufacturer, the scope model, the serial number and the firmware revision level.

#### **QUERY SYNTAX**

\*IDN?

#### **RESPONSE FORMAT**

\*IDN SIGLENT, <model>, <serial\_number>,  
<firmware\_level>  
<model> : = A eleven characters model identifier  
<serial\_number> : = A 14-digit decimal code  
<firmware\_level> : = similar to k.xx.yy.zz

#### **EXAMPLE**

This example issues an identification request to the scope:

Command message:

\*IDN?

Response message:

\*IDN SIGLENT SDS1102CML,SDS00002110025,  
3.01.01.22

### **ACQUISITION**

### **ILVD**

Command/Query

#### **DESCRIPTION**

The INTERLEAVED command enables or disables random interleaved sampling (RIS) for timebase settings where both single shot and RIS mode are available.

The response to the INTERLEAVED? Query indicates whether the oscilloscope is in RIS mode.

#### **COMMAND SYNTAX**

InterLeaVeD <mode>  
<mode> := {ON, OFF}

#### **QUERY SYNTAX**

InterLeaVeD?

#### **RESPONSE FORMAT**

InterLeaVeD <mode>

#### **EXAMPLE**

The following instructs the oscilloscope to use RIS mode:

Command message:  
ILVD ON

#### **RELATED COMMANDS**

TIME\_DIV, TRIG\_MODE

#### **Note:**

This command is suitable for non-SPO models.



### **DISPLAY**

### **INTENSITY,INTS**

Command/Query

#### **DESCRIPTION**

The INTENSITY command sets the intensity level of the grid or the trace.

The intensity level is expressed as a percentage (PCT). A level of 100 PCT corresponds to the maximum intensity whilst a level of 0 PCT sets the intensity to its minimum value.(The minimum value of the trace is 30 PCT)

The response to the INTENSITY? Query indicates the grid and trace intensity levels.

#### **COMMAND SYNTAX**

INTensity GRID, <value>, TRACE, <value>  
<value> : = 0(or 30) to 100 [PCT]

**Note:**

- 1.Parameters are grouped in pairs. The first of the pair names the variable to be modified, whilst the second gives the new value to be assigned. Pairs may be given in any order and be restricted to those variables to be changed.
- 2.The suffix PCT is optional.

#### **QUERY SYNTAX**

INTensity?

#### **RESPONSE FORMAT**

INTensity TRACE, <value>, GRID, <value>

#### **EXAMPLE**

The following instruction enables remote control of the intensity, and changes the grid intensity level to 75%:

Command message:  
INTS GRID, 75

### **STATUS**

### **INR?**

Query

#### **DESCRIPTION**

The INR? query reads and clears the contents of the INternal state change Register (INR). The INR register (table below) records the completion of various internal operations and state transitions.

**Note :**

3.This command only supports 0 bit and 13 bit.

#### **QUERY SYNTAX**

INR?

#### **RESPONSE FORMAT**

INR <value>  
<value> : = 0 to 65535

#### **EXAMPLE**

If we send INR? query after triggering the INR register:

Command message 1:

INR?

Response message 1:

INR 8913

If we send INR? query while the instrument hasn't triggered vet(ARM), the INR register:

Command message 2:

INR?

Response message 2:

INR 8912

If we send INR? query after have sent a INR? query and the mode of the instrument is STOP the INR register:

Command message 3:

INR?

Response message 3:

INR 0

If we send INR? query while there is no trigger then trigger and finally send another INR? query the INR register:

Command message 4:

INR?

Response message 4:

INR 1

### RELATED COMMANDS

ALL\_STATUS? , \*CLS

<b>Internal State Register Structure (INR)</b>			
Bit	Bit Value	Description	
15		0	Reserved for future use
...			
14			
13	8192	1	Trigger is ready
12	4096	1	Pass/Fail test detected desired outcome
11	2048	1	Waveform processing has terminated in Trace D
10	1024	1	Waveform processing has terminated in Trace C
9	512	1	Waveform processing has terminated in Trace B
8	256	1	Waveform processing has terminated in Trace A
7	128	1	A memory card, floppy or hard disk exchange has been detected
6	64	1	Memory card, floppy or hard disk has become full in "AutoStore Fill" mode
5	32	0	Reserved for LeCroy use
4	16	1	A segment of a sequence waveform has been acquired
3	8	1	A time-out has occurred in a data block transfer
2	4	1	A return to the local state is detected
1	2	1	A screen dump has terminated
0	1	1	A new signal has been acquired

**DISPLAY****INVERTSET,INVS**

Command/Query

**DESCRIPTION**

The INVERTSET command inverts the specified traces or the math waveform.

The response to the INVERTSET? query indicates whether the specified waveform is inverted or not.

**COMMAND SYNTAX**

```
<trace>:INVERTSET < state >  
< trace > := {C1,C2,C3,C4,MATH}  
< state >:= {ON,OFF}
```

**QUERY SYNTAX**

```
<trace>:INVERTSET?
```

**RESPONSE FORMAT**

```
<trace>:INVERTSET < state >
```

**EXAMPLE**

The following instruction inverts the trace of channel 1:

```
Command message:  
C1:INVS ON
```

**MISCELLANEOUS**

**LOCK, LOCK**

Command/Query

**DESCRIPTION**

The LOCK command enables or disables the panel keyboard of the instrument.

When any command or query is executed in either local or remote state, the functions of the panel keys except “FORCE” are not available. When the panel keyboard of the instrument is locked, press the “FORCE” key to enable the manual keyboard functions.

The LOCK? query returns the status of the panel keyboard of the instrument.

**COMMAND SYNTAX**

LOCK < state>  
<state>:= {ON,OFF}

**QUERY SYNTAX**

LOCK?

**RESPONSE FORMAT**

LOCK < state>

**EXAMPLE**

The following instruction enables the functions of the panel keys:

Command message:  
LOCK ON

### **DISPLAY**

### **MENU, MENU**

Command/Query

#### **DESCRIPTION**

The MENU command enables or disables to display the menu.

The response to the MENU? query indicates whether the menu is displayed.

#### **COMMAND SYNTAX**

MENU < state>  
<state>:= {ON,OFF}

#### **QUERY SYNTAX**

MENU?

#### **RESPONSE FORMAT**

MENU < state>

#### **EXAMPLE**

The following instruction enables the display of the menu:

Command message:  
MENU ON

#### **Note:**

This command is suitable for non-SPO models.

**ACQUISITION**

**MATH\_VERT\_POS, MTVP**

Command/Query

**DESCRIPTION**

The MATH\_VERT\_POS command controls the vertical position of the math waveform with specified source.

The FFT waveform isn't included. But we have another command which called VPOS to control its vertical position.

The response to the MATH\_VERT\_POS? query indicates the value of the vertical position of the math waveform.

**COMMAND SYNTAX**

MATH\_VERT\_POS <position>

<position>:= the position is related to the position of the screen center. For example, if we set the position of MTVP to 50. The math waveform will be displayed 1 grid up to the vertical center of the screen. Namely one grid is 50.

**QUERY SYNTAX**

MATH\_VERT\_POS?

**RESPONSE FORMAT**

MATH\_VERT\_POS < position >

**EXAMPLE**

The following instruction changes the vertical position of the math waveform to 1 grid up to the screen vertical centre:

Command message:  
MTVP 50

**ACQUISITION**

**MATH\_VERT\_DIV, MTVD**

Command/Query

**DESCRIPTION**

The MATH\_VERT\_DIV command controls the vertical sensitivity of the math waveform of the specified source. We can only set the value of existing math waveforms.

The FFT waveform isn't included.

The response to the MATH\_VERT\_DIV? query indicates the specified scale of math waveform of specified source.

**COMMAND SYNTAX**

MATH\_VERT\_DIV < scale >  
< scale >:= 1PV/div ~ 100V/div.

**QUERY SYNTAX**

MATH\_VERT\_DIV?

**RESPONSE FORMAT**

MATH\_VERT\_DIV < scale >

**EXAMPLE**

The following instruction changes the vertical sensitivity of the math waveform of the specified source to 1V/div:

Command message:  
MTVD 1V



### **FUNCTION**

### **MEMORY\_SIZE, MSIZ**

Command /Query

### **DESCRIPTION**

The MEMORY\_SIZE command sets the maximum depth of memory.

The response to the MEMORY\_SIZE? query the maximal depth of memory.

### **COMMAND SYNTAX**

MEMORY\_SIZE <size>  
<size>:= {7K, 14K, 70K, 140K, 700K, 1.4M,7M,14M}

### **QUERY SYNTAX**

MEMORY\_SIZE?

### **RESPONSE FORMAT**

MEMORY\_SIZE <size>

### **EXAMPLE**

The following instruction sets the maximum depth of memory to 14M.

Command message:  
MSIZ 14M

### **Note:**

This command is suitable for SPO models.

**FUNCTION****MEASURE\_DELAY,MEAD**

Command/Query

**DESCRIPTION**

The MEASURE\_DELY command selects the type of delay measure.

The response to the MEASURE\_DELY? query indicates the type of delay measure.

**COMMAND SYNTAX**

MEASURE\_DELAY <type>,<source>

<source>:= {C1-C2, C1-C3, C1-C4, C2-C3, C2-C4, C3-C4}

<type>:={PHA,FRR,FRF,FFR,FFF,LRR,LRF,LFR,LFF,SKEW}

The PHA is phase, the others are the same as the specified type of the instrument's delay measure.

**QUERY SYNTAX**

<source>:MEASURE\_Delay? <type>

**RESPONSE FORMAT**

<source>:MEAD <type>,<value>

**EXAMPLE**

The following instruction sets the type of delay measure to phase between C1 and C2.

Command message:  
MEAD PHA,C1-C2

### **ACQUISITION**

### **OFFSET, OFST**

Command/Query

#### **DESCRIPTION**

The OFFSET command allows adjustment of the vertical offset of the specified input channel. The maximum ranges depend on the fixed sensitivity setting.

If an out-of-range value is entered, the oscilloscope is set to the closest possible value and the VAB bit (bit 2) in the STB register is set.

The OFFSET? query returns the offset value of the specified channel.

#### **COMMAND SYNTAX**

<channel>: OffSeT <offset>  
<channel> := {C1, C2, C3,C4}  
<offset> := See the oscilloscope's specifications.

#### **QUERY SYNTAX**

<channel>: OffSeT?

#### **RESPONSE FORMAT**

<channel>: OffSeT <offset>

#### **EXAMPLE**

The following command sets the offset of Channel 2 to -3 V:

Command message:  
C2: OFST -3V

### **STATUS**

**\*OPC**

Command/Query

#### **DESCRIPTION**

The \*OPC (Operation Complete) command sets to true the OPC bit (bit 0) in the standard Event Status Register (ESR). This command has no other effect on the operation of the oscilloscope because the instrument starts parsing a command or query only after it has completely processed the previous command or query.

The \*OPC? query always responds with the ASCII character "1" because the oscilloscope only responds to the query when the previous command has been entirely executed.

#### **COMMAND SYNTAX**

\*OPC

#### **QUERY SYNTAX**

\*OPC?

#### **RESPONSE FORMAT**

\*OPC 1

### **MISCELLANEOUS**

**\*OPT?**  
Query

#### **DESCRIPTION**

The \*OPT? query identifies the installed oscilloscope options. The response consists of a series of response fields listing all the installed options.

#### **QUERY SYNTAX**

\*OPT?

#### **RESPONSE FORMAT**

\*OPT <option>

**Note:**

If no option is present, the character 0 will be returned.

**EXAMPLE:** The following instruction queries the installed options:

\*OPT?

Return: \*OPT RS232,NET,USBTMC

***CURSOR***

**PARAMETER\_CLR, PAEL**  
Command

<b>DESCRIPTION</b>	The PARAMETER_CLR command clears the P/F test counter and starts it again at 0.
<b>COMMAND SYNTAX</b>	PAparameter_CLR
<b>RELATED COMMANDS</b>	PARAMETER_VALUE PFDD

### ***CURSOR***

### **PARAMETER\_CUSTOM, PACU**

Command/Query

#### **DESCRIPTION**

The PARAMETER\_CUSTOM command controls the parameters that have customizable qualifiers.

#### **Note:**

The measured value of a parameter setup with PACU can be read by using PAVA?

#### **COMMAND SYNTAX**

PParameter\_CUstom <parameter>,<qualifier>  
<parameter> := {PKPK, MAX, MIN, AMPL, TOP, BASE, CMEAN, MEAN, RMS, CRMS, OVSN, FPPE, OVSP, RPRE, PER, FREQ, PWID, NWID, RISE,FALL,WID,DUTY,NDUTY, ALL}  
<qualifier> := { C1,C2,C3,C4 }  
Measurement qualifier specific to each(source option)

#### **EXAMPLE**

Command Example      PACU PKPK, C1

#### **RELATED COMMANDS**

PARAMETER\_CLR, PARAMETER\_VALUE

**CURSOR**

**PARAMETER\_VALUE?, PAVA?**

Query

**DESCRIPTION**

The PARAMETER\_VALUE query returns the measurement values.

**QUERY SYNTAX**

<trace>:PArAmeter\_VAlue? [<parameter>, ... , <parameter>]

<trace>: = { C1, C2, C3, C4}

<parameter> : = See table of parameter names on previous table.

**RESPONSE FORMAT**

<trace>: PArAmeter\_VAlue <parameter>, <value> [ , ... , <parameter>,<value>]

**EXAMPLE**

The following query reads the rise time of Channel 2

Command message:

C2: PAVA? RISE

Response message:

C2: PAVA RISE, 3.6E-9S

**RELATED COMMANDS**

CURSOR\_MEASURE, CURSOR\_SET, PARAMETER\_CUSTOM

See the table on the following page for all of the parameters:



Parameters Available on All Models				
ALL	all parameters	NDUTY	negative duty cycle	
AMPL	amplitude	NWID	negative width	
BASE	base	OVSN	negative overshoot	
CMEAN	mean for cyclic waveform	OVSP	positive overshoot	
CRMS	root mean square for cyclic part of waveform	PKPK	peak-to-peak	
DUTY	duty cycle	PER	period	
FALL	falltime	RPRE	(Vmin-Vbase)/ Vamp before the waveform rising transition	
FREQ	frequency	PWID	positive width	
FPRE	(Vmin-Vbase)/ Vamp before the waveform falling transition	RMS	root mean square	
MAX	maximum	RISE	risetime	
MIN	minimum	TOP	top	
MEAN	mean	WID	width	
Custom Parameters Defined using PARAMETER_CUSTOM Command				
CUST1	CUST2	CUST3	CUST4	CUST5

**ACQUISITION**

**PEAK\_DETECT, PDET**

Command /Query

**DESCRIPTION**

The PEAK\_DETECT command switches ON or OFF the peak detector built into the acquisition system.

The PEAK\_DETECT? query returns the current status of the peak detector.

**COMMAND SYNTAX**

Peak\_DETEct <state>  
<state> : = {ON, OFF}

**QUERY SYNTAX**

Peak\_DETEct?

**RESPONSE FORMAT**

PDET <state>

**EXAMPLE**

The following instruction turns on the peak detector:

Command message:  
PDET ON

**DISPLAY**

**PERSIST, PERS**

Command /Query

**DESCRIPTION**

The PERSIST command enables or disables the persistence display mode.

**COMMAND SYNTAX**

PERSist <mode>  
<mode> := {ON, OFF}

**QUERY SYNTAX**

PERSist?

**RESPONSE FORMAT**

PERSist <mode>

**EXAMPLE**

The following code turns the persistence display ON:

Command message:  
PERS ON

**RELATED COMMANDS**

PERSIST\_SETUP

**DISPLAY**

**PERSIST\_SETUP, PESU**

Command /Query

**DESCRIPTION**

The PERSIST\_SETUP command selects the persistence duration of the display, in seconds, in persistence mode.

The PERSIST\_SETUP? query indicates the current status of the persistence.

**COMMAND SYNTAX**

PErsist\_SetUp <time>

<time>: = {1, 5, 10, 30, Infinite}

**Note:**

The options of time are the same as your oscilloscope.

**QUERY SYNTAX**

PErsist\_SetUp?

**RESPONSE FORMAT**

PErsist\_SetUp <time>

**EXAMPLE**

The following instruction sets the variable persistence at 5 seconds:

Command message:

PESU 5

**RELATED COMMANDS**

PERSIST

**DISPLAY**

**PANEL\_SETUP, PNSU**

Command /Query

**DESCRIPTION**

The PANEL\_SETUP command complements the \*SAV or \*RST commands. PANEL\_SETUP allows you to archive panel setups in encoded form on external storage media. Only setup data read by the PNSU? query can be recalled.

**COMMAND SYNTAX**

PaNel\_SetUp <setup>  
<setup> : = A setup previously read by PNSU?

**QUERY SYNTAX**

PaNel\_SetUp?

**RESPONSE FORMAT**

PaNel\_SetUp <setup>

**EXAMPLE**

The following instruction saves the oscilloscope's current panel setup in the file PANEL.SET:

Command message:  
PNSU

**RELATED COMMANDS**

\*RCL, \*SAV

**FUNCTION**

**PF\_DISPLAY,PFDS**

Command /Query

**DESCRIPTION**

The PF\_DISPLAY command enables or disables to turn the test and display the message in the pass/fail option.

The response to the PF\_DISPLAY? query indicates whether the test is enabled and the message of pass/fail is displayed

**COMMAND SYNTAX**

PF\_DISPLAY TEST,<state>,DISPLAY,<state>  
<state> := {ON, OFF}

**QUERY SYNTAX**

PF\_DISPLAY TEST?

**RESPONSE FORMAT**

PF\_DISPLAY TEST <state>,DISPLAY,<state>

**EXAMPLE**

The following instruction enables to turn on the test and display the message of pass/fail:

Command message:  
PFDS TEST,ON,DISPLAY,ON

**FUNCTION****PF\_SET,PFST**  
Command /Query**DESCRIPTION**

The PF\_SET command sets the X mask and the Y mask of the mask setting in the pass/fail option.

The response to the PF\_SET? query indicates the value of the X mask and the Y mask.

**COMMAND SYNTAX**

PF\_SET XMASK, <div>,YMASK, <div>  
<div> : = 0.04div~4.0div

**QUERY SYNTAX**

PF\_SET?

**RESPONSE FORMAT**

PF\_SET XMASK, <div>,YMASK, <div>

**EXAMPLE**

The following instruction sets the X mask to 0.4div and the Y mask to 0.5div of the mask setting in the pass/fail option:

Command message:  
PFST XMASK,0.4,YMASK,0.5

**RELATED COMMANDS**

PFSL PFST

**SAVE/RECALL**

**PF\_SAVELOAD,PFSL**

Command

**DESCRIPTION**

The PF\_SAVELOAD command saves or recalls the created mask setting.

**COMMAND SYNTAX**

PF\_SAVELOAD

LOCATION,<location>,ACTION,<action>

The <location> means to save the created mask setting to the internal memories or the external memories.

<location> := {IN,EX}

IN means to save the mask setting to the internal memories while EX means the external memories.

<action> := {SAVE,LOAD}

SAVE means to save the mask setting while LOAD means recall the stored mask setting.

**EXAMPLE**

The following instruction saves the mask setting to the internal memories:

Command message:

PFSL LOCATION,IN,ACTION,SAVE

**RELATED COMMANDS**

PFCM



**FUNCTION**

**PF\_CONTROL,PFCT**

Command/Query

**DESCRIPTION**

The PF\_CONTROL command controls the pass/fail controlling options: “operate”, “output” and the “stop on output”.

See instrument’s Operator Manual for these options

The response to the PF\_CONTROL? query indicates the controlling options of the pass/fail.

**COMMAND SYNTAX**

PF\_CONTROL  
TRACE,<trace>,CONTROL,<control>,OUTPUT,<output>,OUTPUTSTOP,<state>

<trace> := {C1,C2,C3,C4}

<control> := {START,STOP}

<output> := {FAIL,PASS}

<state> := {ON,OFF}

**QUERY SYNTAX**

PF\_CONTROL?

**RESPONSE FORMAT**

PF\_CONTROL  
TRACE,<trace>,CONTROL,<control>,  
OUTPUT,<output>,OUTPUTSTOP,<state>

**EXAMPLE**

The following instruction sets source to channel 1, “operate” to “start”, “output” to “pass” and “stop on output” to “off”:

Command message:

PFCT TRACE,C1,CONTROL,START,  
OUTPUT,PASS,OUTPUTSTOP,OFF

***FUNCTION***

**PF\_CREATEM,PFCM**  
Command

**DESCRIPTION**

The PF\_CREATEM command creates the mask of the pass/fail.

**COMMAND SYNTAX**

PF\_CREATEM

**EXAMPLE**

The following instruction creates the mask of the pass/fail.:

Command message:  
PFCM

**RELATED COMMANDS**

PFSL PFST

**FUNCTION**

**PF\_DATADIS, PFDD**  
Query

**DESCRIPTION**

The PF\_DATADIS? query returns the number of the fail ,pass and total number that the screen showing.

**COMMAND SYNTAX**

PF\_DATADIS?

**RESPONSE FORMAT**

PF\_DATADIS  
FAIL,<num>,PASS,<num>,total,<num>

**EXAMPLE**

The following instruction returns the number of the message display of the pass/fail:

Command message:  
PFDD FAIL,0,PASS,0,TOTAL,0

**RELATED COMMANDS**

PACL

### **SAVE/RECALL SETUP**

**\*RCL**  
Command

#### **DESCRIPTION**

The \*RCL command sets the state of the instrument, using one of the ten non-volatile panel setups, by recalling the complete front-panel setup of the instrument. Panel setup 0 corresponds to the default panel setup.

The \*RCL command produces the opposite effect of the \*SAV command.

If the desired panel setup is not acceptable, the EXecution error status Register (EXR) is set and the EXE bit of the standard Event Status Register (ESR) is set.

#### **COMMAND SYNTAX**

\*RCL <panel\_setup>  
<panel\_setup>:= 0 to 20

#### **EXAMPLE**

The following recalls the instrument setup previously stored in panel setup 3:

Command message:  
\*RCL 3

#### **RELATED COMMANDS**

PANEL\_SETUP, \*SAV, EXR

### **WAVEFORM TRANSFER**

### **RECALL, REC**

Command

#### **DESCRIPTION**

The RECALL command recalls a waveform file from the current directory on mass storage into any or all of the internal memories M1 to M10 (or M20 in the CFL series).

#### **COMMAND SYNTAX**

<memory>: RECall DISK, <device>, FILE, '<filename>'  
<memory> := {M1~M10} (or M1~M20 in the CFL series)  
<device> := {UDSK}  
<filename>: = A waveform file under a legal DOS path. A filename-string of up to eight characters, with the extension ".DAV". (This can include the '/' character to define the root directory.)

#### **EXAMPLE**

The following recalls a waveform file called "C1WF.DAV" from the memory card into Memory M1:

Command message:  
M1: REC DISK, UDSK FILE, 'C1WF.DAV'

#### **RELATED COMMANDS**

STORE, INR?

#### **Note:**

This command is suitable for non-SPO models.

**SAVE/RECALL SETUP**

**RECALL\_PANEL, RCPN**

Command

**DESCRIPTION**

The RECALL\_PANEL command recalls a front-panel setup from the current directory on mass storage.

**COMMAND SYNTAX**

ReCall\_PaNel DISK, <device>, FILE, '<filename>'

<device> := {UDSK}

<filename>: = A waveform file under a legal DOS path . A filename-string of up to eight characters, with the extension “.SET” . (This can include the ‘/’ character to define the root directory.)

**EXAMPLE**

The following recalls the front-panel setup from file SEAN.SET in a USB memory device:

Command message:

RCPN DISK, UDSK, FILE, 'SEAN.SET'

**RELATED COMMANDS**

PANEL\_SETUP, \*SAV, STORE\_PANEL, \*RCL

### ***SAVE/RECALL SETUP***

**\*RST**  
Command

#### **DESCRIPTION**

The \*RST command initiates a device reset.  
The \*RST sets recalls the default setup.

#### **COMMAND SYNTAX**

\*RST

#### **EXAMPLE**

This example resets the oscilloscope:

Command message:

\*RST

#### **RELATED COMMANDS**

\*CAL, \*RCL

**FUNCTION****REF\_SET, REFS**

Command /Query

**DESCRIPTION**

The REF\_SET command sets the reference waveform and its options.

The response to the REF\_SET? query indicates whether the specified reference waveform is turned on.

**COMMAND SYNTAX**

REF \_ SET TRACE,<trace>REF,<ref>,state,<state>,**SAVE,DO**

<trace> := {C1,C2,C3,C4,MATH}

<ref> := {RA,RB,RC,RD}

The Rx(x is A,B,C,D) is that which one can be stored or displayed

<state> := {ON,OFF}

The state enables or disables to display the specified reference waveform.

If the command syntax include 'SAVE,DO', the specified trace will be saved to the specified reference waveform.

**QUERY SYNTAX**

REF \_ SET? REF,<ref>

**RESPONSE FORMAT**

REF \_ SET REF,<ref>,STATE,<state>

**EXAMPLE**

The following instruction saves the channel 1 waveform to the REFA, and turns on REFA:

Command message:

REFS TRACE,C1,REF,RA,

STATE,ON,SAVE,DO



### **SAVE/RECALL SETUP**

**\*SAV**  
Command

#### **DESCRIPTION**

The \*SAV command stores the current state of the instrument in internal memory. The \*SAV command stores the complete front-panel setup of the instrument at the time the command is issued.

#### **COMMAND SYNTAX**

\*SAV <panel\_setup>  
<panel\_setup>: = 1 to 20

#### **EXAMPLE**

The following saves the current instrument setup in Panel Setup 3:

Command message:  
\*SAV 3

#### **RELATED COMMANDS**

PANEL\_SETUP, \*RCL

***HARD COPY***

**SCREEN\_DUMP,SCDP**

Command

**DESCRIPTION**

The SCREEN\_DUMP command is used to obtain the screen information of image format .

**COMMAND SYNTAX**

Screen\_Dump

**EXAMPLE**

The following command transfers the screen information of image format to the controller

Command message:  
SCDP

### **DISPLAY**

### **SCREEN\_SAVE,SCSV**

Command/Query

#### **DESCRIPTION**

The SCREEN\_SAVE command controls the automatic Screen Saver, which automatically shuts down the internal color monitor after a preset time.

The response to the SCREEN\_SAVE? query indicates whether the automatic screen saver feature is on or off.

**Note:**

1. When the screen save is in effect, the oscilloscope is still fully functional.

#### **COMMAND SYNTAX**

SCreen\_SaVe <enabled>  
<enabled> : = { YES, NO }

#### **QUERY SYNTAX**

SCreen\_SaVe?

#### **RESPONSE FORMAT**

SCreen\_SaVe <enabled>

#### **EXAMPLE**

The following enables the automatic screen saver:

Command message:  
SCSV YES

**STATUS****\*SRE**  
Command/Query**DESCRIPTION**

The \*SRE command sets the Service Request Enable register (SRE). This command allows the user to specify which summary message bit(s) in the STB register will generate a service request.

A summary message bit is enabled by writing a '1' into the corresponding bit location. Conversely, writing a '0' into a given bit location prevents the associated event from generating a service request (SRQ). Clearing the SRE register disables SRQ interrupts.

The \*SRE? query returns a value that, when converted to a binary number, represents the bit settings of the SRE register.

Note:

1. That bit 6 (MSS) cannot be set and its returned value is always zero.

**COMMAND SYNTAX**

\*SRE <value>  
<value> : = 0 to 255

**QUERY SYNTAX**

\*SRE?

**RESPONSE FORMAT**

\*SRE <value>

**EXAMPLE**

The following instruction allows an SRQ to be generated as soon as the MAV summary bit (bit 4, i.e. decimal 16) or the INB summary bit (bit 0, i.e. decimal 1) in the STB register, or both, are set. Summing these two values yields the SRE mask  $16+1 = 17$ .

Command message:

\*SRE 17

### **STATUS**

### **\*STB?**

Query

#### **DESCRIPTION**

The \*STB? query reads the contents of the 488.1 defined status register (STB), and the Master Summary Status (MSS). The response represents the values of bits 0 to 5 and 7 of the Status Byte register and the MSS summary message.

The response to a \*STB? Query is identical to the response of a serial poll except that the MSS summary message appears in bit 6 in place of the RQS message.

#### **QUERY SYNTAX**

\*STB?

#### **RESPONSE FORMAT**

\*STB <value>  
<value> : = 0 to 255

#### **EXAMPLE**

The following reads the status byte register:

Command message:  
\*STB?

Response message:  
\*STB 0

#### **RELATED COMMANDS**

ALL\_STATUS,\*CLS,\*SRE

**ADDITIONAL INFORMATION**

<b>Status Byte Register (STB)</b>				
Bit	Bit Value	Bit Name	Description	Not
7	128	DIO7	0 reserved for future use	
6	64	MSS/RQS MSS=1 RQS=1	at least 1 bit in STB masked by SRE is 1 service is requested	(1) (2)
5	32	ESB	1 an ESR enabled event has occurred	(3)
4	16	MAV	1 output queue is not empty	(4)
3	8	DIO3	0 reserved	
2	4	VAB	1 a command data value has been adapted	(5)
1	2	DIO1	0 reserved	
0	1	INB	1 an enabled INTERNAL state change has occurred	(6)

Notes

- (1) The Master Summary Status (MSS) indicates that the instrument requests service, whilst the Service Request status — when set — specifies that the oscilloscope issued a service request. Bit position 6 depends on the polling method:  
Bit 6 = MSS if an \*STB? Query is received  
= RQS if serial polling is conducted
- (2) Example: If SRE=10 and STB=10 then MSS=1. If SRE=010 and STB=100 then MSS=0.
- (3) The Event Status Bit (ESB) indicates whether or not one or more of the enabled IEEE 488.2 events have occurred since the last reading or clearing of the Standard Event Status Register (ESR). ESB is set if an enabled event becomes true (1).
- (4) The Message Available bit (MAV) indicates whether or not the Output queue is empty. The MAV summary bit is set true (1) whenever a data byte resides in the Output queue.
- (5) The Value Adapted Bit (VAB) is set true (1) whenever a data value in a command has been adapted to the nearest legal value. For instance, the VAB bit would be set if the timebase is redefined as 2  $\mu$ s/div since the adapted value is 2.5  $\mu$ s/div.
- (6) The Internal state Bit (INB) is set true (1) whenever certain enabled internal states are entered. For further information, refer to the INR query.

### ***ACQUISITION***

### **STOP** Command

#### **DESCRIPTION**

The STOP command immediately stops the acquisition of a signal. If the trigger mode is AUTO or NORM.

#### **QUERY SYNTAX**

STOP

#### **EXAMPLE**

The following stops the acquisition process:

Command message:

\*STOP

Response message:

\*STB 0

#### **RELATED COMMANDS**

ARM\_ACQUISITION, TRIG\_MODE, WAIT

### **WAVEFORM TRANSFER**

### **STORE, STO**

Command

#### **DESCRIPTION**

The STORE command stores the contents of the specified trace into the current directory in a USB memory device.

#### **COMMAND SYNTAX**

STOre <trace>

<trace>: = {TA, TB, TC, TD, C1, C2, C3, C4, ALL\_DISPLAYED}

<dest>: = { UDSK }

#### **Note:**

- 1.If the STORE command is sent without any argument, and the current trace isn't enabled, the current trace will be enabled and stored in the Store Setup. This setup can be modified using the STORE\_SETUP command.
- 2.The <dest> parameter is vary with oscilloscope's models. If your oscilloscope is non-SPO models , this parameter's options are {M1~M10(or M20 in the CFL series)}, UDSK}. If your oscilloscope is SPO model, this parameter's option is {UDSK}.

#### **EXAMPLE**

The following command stores the contents of Channel 1(C1) into USB memory device:

Command message:

STO C1, UDSK

The following command stores all currently displayed waveforms onto the USB memory device:

Command message:

STO ALL\_DISPLAYED, UDSK

The following command stores the contents of Channel 1(C1) into Memory 1 (M1):

Command message:



STO C1, M1

**RELATED COMMANDS**

STORE\_SETUP, RECALL

## **SAVE/RECALL SETUP**

## **STORE\_PANEL,STPN**

Command

### **DESCRIPTION**

The STORE\_PANEL command stores the complete front-panel setup of the instrument, at the time the command is issued, into a file on the specified-DOS path directory in a USB memory device.

### **COMMAND SYNTAX**

STore\_PaNel DISK, <device>, FILE,  
'<filename>'  
<device>: = {UDSK}  
< directory >: = A legal DOS path or filename.  
A filename -string of up to 8 characters, with the extension ".SET". (This can include the '/' character to define the root directory.)

### **EXAMPLE**

The following code saves the current instrument setup to root directory of the USB memory device in a file called "SEAN.SET":

Command message:

```
STore_PaNel DISK,UDSK,FILE,'SEAN.SET'
```

The following code saves the current instrument setup to specified-directory of the USB memory device in a file called "SEAN.SET":

Command message:

```
STore_PaNel DISK,UDSK,FILE,  
'/AAA/SEAN'
```

### **RELATED COMMANDS**

\*SAV, RECALL\_PANEL, \*RCL

### **WAVEFORM TRANSFER**

### **STORE\_SETUP,STST**

Command/Query

#### **DESCRIPTION**

The STORE\_SETUP command controls the way in which traces will be stored. A single trace or all displayed traces may be enabled for storage.

#### **COMMAND SYNTAX**

STore\_SeTup [<trace>, <dest>]  
<trace>:= {C1,C2,C3,C4,ALL\_DISPLAYED }  
<dest>:={UDSK}

#### **Note:**

The <dest> parameter is vary with oscilloscope's models. If your oscilloscope is not an SPO model, it's options are {M1~M10(or M20 in the CFL series)}, UDSK}. If your oscilloscope is an SPO model, its option is {UDSK}.

#### **QUERY SYNTAX**

STore\_SeTup?

#### **RESPONSE FORMAT**

STore\_SeTup <trace>, <dest>

#### **EXAMPLE**

The following command selects Channel 1 to be stored.

Command message:  
STST C1, UDSK

#### **RELATED COMMANDS**

STORE,INR

**ACQUISITION**

**SAMPLE\_STATUS,SAST**

Query

**DESCRIPTION**

The SAST? query the acquisition status of the scope.

**QUERY SYNTAX**

SAST?

**RESPONSE FORMAT**

SAST < status >

**EXAMPLE**

The following command reads the acquisition status of the scope.

Command message:

SAST?

Response message:

SAST trig'd

## **ACQUISITION**

## **SAMPLE\_RATE,SARA**

Query

### **DESCRIPTION**

The SARA? query returns the sample rate of the scope.

### **QUERY SYNTAX**

SARA?

### **RESPONSE FORMAT**

SARA< value >

### **EXAMPLE**

The following command reads the sample rate of the scope.

Command message:

SARA?

Response message:

SARA 500.0kSa

**ACQUISITION**

**SAMPLE\_RATE,SANU**

Query

**DESCRIPTION**

The SANU? query returns the number of sampled points available from last acquisition and the trigger position.

**QUERY SYNTAX**

SANU? <channel>

**RESPONSE FORMAT**

SANU <value>

**EXAMPLE**

The following command reads the number of sampled points available from last acquisition from the Channel 2.

Command message:  
SANU? C2

Response message:  
SANU 6000

### ***FUNCTION***

**SET50,SET50**  
Command

### **DESCRIPTION**

The SET50 command sets the trigger level of the specified trigger source to the centre of the signal amplitude.

### **COMMAND SYNTAX**

SET50

### **EXAMPLE**

The following command sets the trigger level of the specified trigger source to the centre of the signal amplitude

Command message:  
SET50

### **Note:**

This command is suitable for non-SPO models.

**ACQUISITION**

**SKEW,SKEW**  
Command

**DESCRIPTION**

The SKEW command sets the skew value of the specified trace.

The response to the SKEW? query indicates the skew value of the specified trace.

**COMMAND SYNTAX**

<trace>:SKEW <skew>  
<trace> := { C1,C2,C3,C4 }  
<skew>: = it is a value about time.

**QUERY SYNTAX**

<trace>:SKEW?

**RESPONSE FORMAT**

<trace>:SKEW <skew>

**EXAMPLE**

The following command sets channel 1 skew value to 3ns

Command message:  
C1:SKEW 3NS



**ACQUISITION**

**SINXX\_SAMPLE, SXSA**

Command/Query

**DESCRIPTION**

The SINXX\_SAMPLE command sets the way of interpolation.

The response to the SINXX\_SAMPLE? query indicates the way of interpolation.

**COMMAND SYNTAX**

SINXX\_SAMPLE, <state>

<state> := {ON,OFF}

ON means sine interpolation, and OFF means linear interpolation

**QUERY SYNTAX**

SINXX\_SAMPLE?

**RESPONSE FORMAT**

SINXX\_SAMPLE <state>

**EXAMPLE**

The following instruction sets the way of the interpolation to sine interpolation:

Command message:

SXSA ON

### **ACQUISITION**

### **TIME\_DIV,TDIV**

Command/Query

#### **DESCRIPTION**

The TIME\_DIV command modifies the timebase setting. The new timebase setting may be specified with suffixes: NS for nanoseconds, US for microseconds, MS for milliseconds, S for seconds, or KS for kiloseconds. An out-of-range value causes the VAB bit (bit 2) in the STB register to be set.

The TIME\_DIV? query returns the current timebase setting.

#### **COMMAND SYNTAX**

Time\_DIV <value>  
<value>:={ 1NS,2NS,5NS,10NS,20NS,50NS,100NS,200NS,500NS,1US,2US,5US,10US,20US,50US,100US,200US,500US,1MS,2MS,5MS,10MS,20MS,50MS,100MS,200MS,500MS,1S,2S,5S,10S,20S,50S}

#### **QUERY SYNTAX**

Time\_DIV?

#### **RESPONSE FORMAT**

Time\_DIV <value>

#### **EXAMPLE**

The following sets the time base to 500  $\mu$ s /div:

Command message:  
TDIV 500US

#### **RELATED COMMANDS**

TRIG\_DELAY, TRIG\_MODE

**WAVEFORM TRANSFER**

**TEMPLATE, TMPL**

Query

**DESCRIPTION**

The TEMPLATE? query produces a copy of the template that describes the various logical entities making up a complete waveform. In particular, the template describes in full detail the variables contained in the descriptor part of a waveform.

**QUERY SYNTAX**

TeMPLate?

**RESPONSE FORMAT**

TeMPLate "<template>"

<template>: = A variable length string detailing the structure of a waveform.

**RELATED COMMANDS**

WF

### **DISPLAY**

### **TRACE, TRA**

Command/Query

#### **DESCRIPTION**

The TRACE command enables or disables the display of a trace. An environment error is set if an attempt is made to display more than four waveforms.

The TRACE? query indicates whether the specified trace is displayed or not.

#### **COMMAND SYNTAX**

<trace>: TRAcE <mode>  
<trace> := {C1, C2, C3, C4, TA, TB, TC, TD}  
<mode> := {ON, OFF}

#### **QUERY SYNTAX**

<trace>: TRAcE?

#### **RESPONSE FORMAT**

<trace>: TRAcE <mode>

#### **EXAMPLE**

The following command displays Channel 1(C1):

Command message:  
C1: TRA ON

### ***ACQUISITION***

**\*TRG**  
Command

#### **DESCRIPTION**

The \*TRG command executes an ARM command.

#### **COMMAND SYNTAX**

\*TRG

#### **EXAMPLE**

The following command enables signal acquisition:

Command message:  
\*TRG

#### **RELATED COMMANDS**

ARM\_ACQUISITION, STOP, WAIT

## **ACQUISITION**

## **TRIG\_COUPLING, TRCP**

Command /Query

### **DESCRIPTION**

The TRIG\_COUPLING command sets the coupling mode of the specified trigger source.

The TRIG\_COUPLING? query returns the trigger coupling of the selected source.

### **COMMAND SYNTAX**

<trig\_source>: TRig\_CouPling <trig\_coupling>  
<trig\_source>: = {C1, C2, C3, C4, EX, EX5, LINE}  
<trig\_coupling>: = {AC,DC,HFREJ,LFREJ}

### **QUERY SYNTAX**

<trig\_source>: TRig\_CouPling?

### **RESPONSE FORMAT**

<trig\_source>: TRig\_CouPling <trig\_coupling>

### **EXAMPLE**

The following command sets the coupling mode of the trigger source Channel 2 to AC:

Command message:  
C2: TRCP AC

### **RELATED COMMANDS**

TRIG\_COUPLING, TRIG\_DELAY,  
TRIG\_LEVEL, TRIG\_MODE, TRIG\_SELECT,  
TRIG\_SLOPE

**ACQUISITION****TRIG\_DELAY, TRDL**

Command /Query

**DESCRIPTION**

The TRIG\_DELAY command sets the time at which the trigger is to occur with respect to the first acquired data point.

This mode is called pre-trigger acquisition, as data are acquired before the trigger occurs. Negative trigger delays must be given in seconds. This mode is called post-trigger acquisition, as the data are acquired after the trigger has occurred.

If a value outside the range, the trigger time will be set to the nearest limit and the VAB bit (bit 2) will be set in the STB register. The response to the TRIG\_DELAY? query indicates the trigger time with respect to the first acquired data point.

**COMMAND SYNTAX**

TRig\_DeLay <value>  
<value> : = the range of value is related to the timebase.

**Note:**

The suffix S is optional and assumed.

**QUERY SYNTAX**

TRig\_DeLay?

**RESPONSE FORMAT**

TRig\_DeLay <value>

**EXAMPLE**

The following command sets the trigger delay to -2ms (postrigger):

Command message:  
TRDL -2MS

**RELATED COMMANDS**

TIME\_DIV, TRIG\_COUPLING, TRIG\_LEVEL,  
TRIG\_MODE, TRIG\_SELECT, TRIG\_SLOPE

**ACQUISITION****TRIG\_LEVEL, TRLV**

Command /Query

**DESCRIPTION**

The TRIG\_LEVEL command adjusts the trigger level of the specified trigger source. An out-of-range value will be adjusted to the closest legal value and will cause the VAB bit (bit 2) in the STB register to be set.

The TRIG\_LEVEL? query returns the current trigger level.

**COMMAND SYNTAX**

```
<trig_source>: TRig_LeVel <trig_level>  
<trig_source>: = {C1, C2, C3, C4, EX, EX5}  
<trig_level>: = -4.5DIV* volt/div to 4.5DIV *  
volt/div
```

**Note:**

The suffix V is optional and assumed.

**QUERY SYNTAX**

```
<trig_source>: TRig_LeVel?
```

**RESPONSE FORMAT**

```
<trig_source>: TRig_LeVel <trig_level>
```

**EXAMPLE**

The following code adjusts the trigger level of Channel 3 to 52.00mv:

Command message:

```
C3:TRig_LeVel 52.00mv
```

**RELATED COMMANDS**

TRIG\_COUPLING, TRIG\_DELAY,  
TRIG\_MODE, TRIG\_SELECT, TRIG\_SLOPE



### **ACQUISITION**

### **TRIG\_LEVEL2, TRLV2**

Command /Query

#### **DESCRIPTION**

The TRIG\_LEVEL2 command adjusts the second trigger level of the specified trigger source. An out-of-range value will be adjusted to the closest legal value and will cause the VAB bit (bit 2) in the STB register to be set.

The TRIG\_LEVEL? query returns the current trigger level.

#### **COMMAND SYNTAX**

```
<trig_source>: TRig_LeVel2 <trig_level>  
<trig_source>: = {C1, C2, C3, C4, EX, EX5}  
<trig_level>: = -4.5DIV* volt/div to 4.5DIV *  
volt/div
```

Note:

The suffix V is optional and assumed.

#### **QUERY SYNTAX**

```
<trig_source>: TRig_LeVel2?
```

#### **RESPONSE FORMAT**

```
<trig_source>: TRig_LeVel <trig_level>
```

#### **EXAMPLE**

The following code adjusts the trigger level of Channel 3 to 52.00mv:

Command message:

```
C3:TRig_LeVel 52.00mv
```

#### **RELATED COMMANDS**

TRIG\_COUPLING, TRIG\_DELAY,  
TRIG\_MODE, TRIG\_SELECT, TRIG\_SLOPE

#### **Note:**

This command is suitable for non-SPO models.

## **ACQUISITION**

## **TRIG\_MODE, TRMD**

Command /Query

### **DESCRIPTION**

The TRIG\_MODE command specifies the trigger mode.

The TRIG\_MODE? query returns the current trigger mode.

**Note:**

STOP is a part of the option of this command, but is not a trigger mode of the instrument.

### **COMMAND SYNTAX**

TRig\_MoDe <mode>  
<mode>: = {AUTO, NORM, SINGLE,STOP}

**Note:**

The suffix V is optional and assumed.

### **QUERY SYNTAX**

TRig\_MoDe?

### **RESPONSE FORMAT**

TRig\_MoDe <mode>

### **EXAMPLE**

The following selects the normal mode:

Command message:  
TRMD NORM

### **RELATED COMMANDS**

ARM\_ACQUISITION, STOP, TRIG\_SELECT,  
TRIG\_COUPLING, TRIG\_LEVEL,TRIG\_SLOP

**ACQUISITION****TRIG\_SELECT, TRSE**

Command /Query

**DESCRIPTION**

The TRIG\_SELECT command selects the condition that will trigger the acquisition of waveforms. Depending on the trigger type, additional parameters must be specified. These additional parameters are grouped in pairs. The first in the pair names the variable to be modified, while the second gives the new value to be assigned. Pairs may be given in any order and restricted to those variables to be changed.

The TRIG\_SELECT? query returns the current trigger condition.

Trigger Notation			
EDGE	Edge	PS	Pulse smaller
GLIT	Glitch	SR	Source
HV	Hold value	TI	Time
HT	Hold type	TV	TV
IL	Interval larger	CHAR	Characteristics
INTV	Interval	LPIC	Lines per picture
IS	Interval smaller	LINE	Line
PL	Pulse larger		

**COMMAND SYNTAX  
(for all but TV trigger)**

TRig\_Select  
 <trig\_type>,SR,<source>,HT,<hold\_type>,HV,<hold\_value>  
 <trig\_type> := { EDGE, GLIT,SLEW, INTV }  
 <source> := { C1, C2, C3, C4, LINE,EX,EX5 }  
 <hold\_type> := {TI,PS,PL,P2,IS,IL,I2,OFF,EV }  
 <hold\_value> := See instrument Operator's Manual for valid values.

**Note:**

The <hold type> varies with models. If your oscilloscope is an SPO model, hold type's options are {TI,PS,PL,P2,IS,IL,I2,OFF,EV}, else ,hold type's options are {TI, PS, PL,PE, IS, IL,IE}.

### QUERY SYNTAX

TRig\_SELECT?

### RESPONSE FORMAT

TRig\_Select <trig\_type>, SR, <source>, HT, <hold\_type>, HV, <hold\_value>

### EXAMPLE

The following selects the EDGE trigger with Channel 1 as trigger source. Hold type and hold-value are chosen as "time" and 1.43US:

Command message:

TRSE EDGE, SR, C1, HT, TI, HV, 1.43US

### TV COMMAND SYNTAX

Format 1:

TRig\_SELECT

TV,SR,<source>,FLDC,<field\_count>,FLD,<field>,<CHAR,<characteristics>,IPIC,<ipic>,ILAC,<ilace>,LINE, <line>

<trig\_type>:= {TV}

<source>:= {C1, C2, C3,C4 }

<field\_count>:= {1,2,4,8}

<field>:=1 to field\_count

<characteristics>:=

{NTSC,PALSEC,720P/50,720P/60,1080P/50,1080P/60,1080I/50,1080I/60,CUSTOM}

<ipic>:=1 to 1500

<ilace>:= {1,2,4,8}

<line>:= 1 to 525 (PALSEC)

1 to 625(NTSC)

#### Note:

This format is suitable for SPO models.

Format 2:

TRig\_SelEct

TV,SR,<source>,CHAR,<characteristic>,POL,<polarity>,SYNC,<sync\_type>,LINE,<line>

OPTION:

<trig\_type>:= { TV }

SR,< source >: is used to set the trigger channel. If you want to set the other options. You must set use the same trigger channel.

<source>:= {C1, C2, C3,C4,EX, EX5}

POL,<polarity>: is used to set polarity, If you want to set it. You must set <trig\_type> to TV.

<polarity>: = {PO,NE}

PO means positive. NE means negative.

CHAR, <characteristics>: is used to set the standard. If you want to set it, the <trig\_type> must be set to TV.

<characteristics>:={NTSC, PALSEC}

SYNC,<sync\_type>: is used to set sync. If you want to set it. You must set <trig\_type> to TV

<sync\_type> : = {AL,LN,OF,EF}

AL means all lines; LN means line num; OF means odd field; EF means even field.

LINE,<line>: is used to set the line num. if you want to set it. The SYNC must be set to

LINENUM

VERT,<vertical>: is used to set vertical. If you want to set it. You must set <trig\_type> SLEW

<vertical>: = {UP,DOWN,BOTH}

**Note:**

This format is suitable for non-SPO models.

### RELATED COMMANDS

TRIG\_COUPLING, TRIG\_DELAY,  
TRIG\_LEVEL, TRIG\_MODE, TRIG\_SLOPE

**ACQUISITION**

**TRIG\_SLOPE, TRSL**

Command /Query

**DESCRIPTION**

The TRIG\_SLOPE command sets the trigger slope of the specified trigger source.

The TRIG\_SLOPE? query returns the trigger slope of the selected source.

**COMMAND SYNTAX**

<trig\_source>: TRig\_Slope <trig\_slope>  
<trig\_source>: = {C1, C2, C3, C4, EX,EX5 }  
<trig\_slope>: = {NEG,POS,WINDOW}

**QUERY SYNTAX**

<trig\_source>: TRig\_Slope?

**RESPONSE FORMAT**

<trig\_source>: TRig\_Slope <trig\_slope>

**EXAMPLE**

The following sets the trigger slope of Channel 2 to negative:

Command message:  
C2: TRSL NEG

**RELATED COMMANDS**

TRIG\_COUPLING,TRIG\_DELAY,TRIG\_LEVEL,TRIG\_MODE,TRIG\_SELECT, TRIG\_SLOPE

## **ACQUISITION**

## **TRIG\_WINDOW, TRWI**

Command /Query

### **DESCRIPTION**

The TRIG\_WINDOW command sets the relative height of the two trigger line of the trigger window type.

The TRIG\_WINDOW? query returns relative height of the two trigger line of the trigger window type.

### **COMMAND SYNTAX**

TRig\_WInDow <value>

< value >: -4.5DIV\* volt/div to 4.5DIV \* volt/div

### **QUERY SYNTAX**

TRig\_WInDow?

### **RESPONSE FORMAT**

TRig\_WInDow < value >

### **EXAMPLE**

The following sets the relative height of the two trigger line of the trigger window type to 2V:

Command message:

TRWI 2V

### **RELATED COMMANDS**

TRIG\_LEVEL, TRIG\_LEVEL2, TRIG\_SE

## **ACQUISITION**

## **TRIG\_PATTERN, TRPA**

Command /Query

### **DESCRIPTION**

The TRIG\_PATTERN command sets the condition of the pattern trigger.

The TRIG\_PATTERN? query returns the condition of the pattern trigger.

### **COMMAND SYNTAX**

TRig\_Pattern  
<source>,<status>[,<source>,<status>][,<source>,<status>][,<source>,<status>],STATE,<condition>  
< source >:={C1, C2, C3, C4}  
<status>:={X,L,H}  
< condition >:={AND, OR, NAND, OR}

### **QUERY SYNTAX**

TRig\_PAttern?

### **RESPONSE FORMAT**

TRig\_Pattern<source>,<status>,<source>,<status>,<source>,<status>

### **EXAMPLE**

The following sets the channel 2 and channel 3 to low and the condition to AND:

Command message:  
TRPA C2,L,C3,L,STATE,AND

### **RELATED COMMANDS**

TRIG\_LEVEL, TRIG\_LEVEL2,TRIG\_SELECT

#### **Note:**

This command is suitable for SPO models.



### **ACQUISITION**

### **UNIT, UNIT**

Command /Query

#### **DESCRIPTION**

The UNIT command sets the unit of the specified trace.

The UNIT query returns the unit of the specified trace.

#### **COMMAND SYNTAX**

<channel>: UNIT <type>  
<channel>: = {C1, C2, C3, C4}  
<type>: = {V,A}

#### **QUERY SYNTAX**

<channel> : UNIT?

#### **RESPONSE FORMAT**

<channel>: UNIT <type>

#### **EXAMPLE**

The following command sets the unit of the channel 1 to V:

Command message:  
C1: UNIT V

### **DISPLAY**

### **VERT\_POSITION,VPOS**

Command /Query

#### **DESCRIPTION**

The VERT\_POSITION command adjusts the vertical position of the specified FFT trace on the screen. It does not affect the original offset value obtained at acquisition time.

The VERT\_POSITION? query returns the current vertical position of the specified FFT trace.

#### **COMMAND SYNTAX**

```
<trace>: Vert_POSITION <display_offset>  
<trace>: = {TA, TB, TC, TD}  
<display_offset>: =-40 DIV to 40 DIV
```

Note:

The suffix DIV is optional.

#### **QUERY SYNTAX**

```
<trace>: Vert_POSition?
```

#### **RESPONSE FORMAT**

```
<trace>: Vert_POSITION <display_offset>
```

#### **EXAMPLE**

The following shifts FFT Trace A (TA) upwards by +3 divisions relative to the position at the time of acquisition:

Command message:

```
TA: VPOS 3DIV
```

### **ACQUISITION**

### **VOLT\_DIV, VDIV**

Command /Query

#### **DESCRIPTION**

The VOLT\_DIV command sets the vertical sensitivity in Volts/div. The VAB bit (bit 2) in the STB register is set if an out-of-range value is entered.

The VOLT\_DIV query returns the vertical sensitivity of the specified channel.

#### **COMMAND SYNTAX**

<channel>: Volt\_DIV <v\_gain>  
<channel>: = {C1, C2, C3, C4}  
<v\_gain>: = 2mV to 10V

**Note:**

The suffix V is optional.

#### **QUERY SYNTAX**

<channel> : Volt\_DIV?

#### **RESPONSE FORMAT**

<channel>: Volt\_DIV <v\_gain>

#### **EXAMPLE**

The following command sets the vertical sensitivity of channel 1 to 50 mV/div:

Command message:  
C1: VDIV 50MV

**ACQUISITION****VERTICAL, VTCL**

Command /Query

**DESCRIPTION**

The VERTICAL command controls the vertical position of the slope trigger line. It is related to the TRSE command. The VERT option of the TRSE command changes the controlling type of the slopes trigger line.

When the slope trigger lines are both controlled, the vertical position of the slope trigger line is the up one's position.

The VERTICAL query returns the vertical position of the slope trigger line.

**COMMAND SYNTAX**

<channel>: VERTICAL <pos>

<channel>: = {C1, C2, C3, C4}

<pos>: = the position is related to the screen vertical center. For example, if we set the vertical position of the slope trigger line to 25, it will be displayed 1 grid up to the screen vertical center. Namely one grid is 25.

**QUERY SYNTAX**

<channel> : VERTICAL?

**RESPONSE FORMAT**

<channel>: VERTICAL <pos>

**EXAMPLE**

The following command sets the vertical position of the slope trigger line to 25 that what is the distance from the up of centre about 1 grid :

Command message:  
C1: VTCL 25

**RELATED COMMANDS**

TRSE

**WAVEFORM TRANSFER****WAVEFORM,WF**  
Query**DESCRIPTION**

A WAVEFORM? Query transfers a waveform from the oscilloscope to the controller.

**Note:**

1. The format of the waveform data depends on the current settings specified by the last WAVEFORM\_SETUP command.
2. The format of the waveform data can be seen by the TEMPLATE? Query.

**QUERY SYNTAX**

<trace>: WaveForm? [<section>]

<trace> := { C1,C2,C3,C4}

<section>:= {DESC, DAT2,ALL}

DESC: Return descriptor. The length of descriptor is 346 bytes. This includes the information necessary to reconstitute the display of the waveform from the data, including: your oscilloscope name and serial number, the encoding format used for the data blocks, and miscellaneous constants.

DAT2: Return the main data include the head, the wave data and the ending flag . The length of data is current memory depth.

ALL: Return the descriptor and data.

**RESPONSE FORMAT**

<trace>: WaveForm <waveform\_data\_block>

**EXAMPLE**

The following command reads waveform data of Channel 1, and current memory depth is 70pts.

Command message:

C1: WF? DAT2

Response message:

As follow picture:

The head of message: C1:WF ALL. These are followed by the string #90000070, the beginning of a binary block in which nine ASCII integers are used to give the length of the block (70 bytes).After the length of block, is beginning of wave data. At the last meet “0A 0A”, means the end of data.

Data	Description
43 31 3A 57 46 20 41 4C 4C 2C 23 39 30 30 30 30	C1:WF ALL,#90000
30 30 30 37 30 02 03 03 03 03 03 01 00 FE FC F9	00070.....
F7 F3 F0 ED E9 E6 E3 DF DC D9 D6 D3 D1 CF CE CD	.....
CC CC CC CD CE CF D1 D4 D6 D9 DC E0 E2 E6 EA ED	.....
F1 F4 F7 FA FC FE 00 02 02 03 03 03 02 01 00 FE	.....
FC F9 F6 F3 F0 ED EA E6 E2 DF DC 0A 0A	.....

How to use the data recovery waveform:

- 1.To calculate the voltage value corresponding to the data point.

Using the formula : voltage value(V) = code value \*( vdiv /25)- voffset.  
code value: The decimal of wave data .

Note: If the decimal is greater than “127”, it should minus 255.Then the value is code value. Such as the wave data is “FC” convert to decimal is “252”. So the code value is 252-255=-3.

vdiv: The Volts/div value.

voffset: The voltage position value.

The following picture as an example:

Send command “C1:VDIV?”,return” C1:VDIV 5.00E-01V”.

Get the current Volts/div values: vdiv = 0.5V.

Send command “C1:OFST?”,return” C1:OFST -5.00E-01V”

Get the current voltage position values: voffset = -0.5V.

According the wave data, we can know the first point of wave data is the “02” convert to decimal is “2”(Hexadecimal converted to decimal).

The first point of wave data voltage value = 2\*(0.5/25)-(-0.5) = 0.54V.

- 2.To calculate the time value of the first data point.

Using the formula : time value(S) = trdl-( timebase\*grid/2).

trdl: The time value which is center of the screen.

timebase: The timebase value.

grid: The grid numbers in horizontal direction.

The following picture as an example:

Send command “TRDL?”,return” TRDL -5.00000ns”.

Get the current time value center of the screen: trdl = -5.00E-09s.

Send command “TDIV?”,return” TDIV 5.00E-09S”.

Get the current timebase: timebase = 5.00E-09S.

The time value of the first data point: time value = -5.00E-09 – (5.00E-09\*14/2) = -40.00E-09(s)=-40(ns).

Send command “SARA?”,return” SARA 1.00GSa/s”.

Get the current sampling rate: sampling rate= 1.00GSa/s.

The time interval: time inter = 1/ sampling rate = 1ns

So the time value of the second data point: value = -40ns+1ns = -39ns

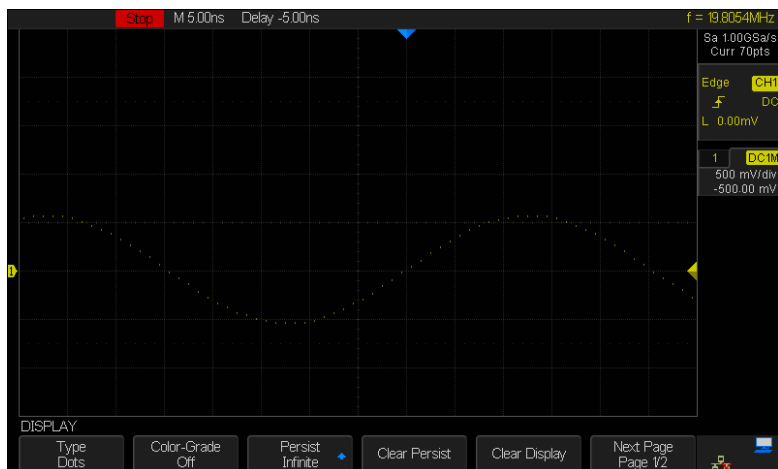

**WAVEFORM TRANSFER****WAVEFORM\_SETUP, WFSU**

Command/Query

**DESCRIPTION**

The WAVEFORM\_SETUP command specifies the amount of data in a waveform to be transmitted to the controller. The command controls the settings of the parameters listed below.

Note:

FP	First point
SP	Sparsing
NP	The number of points

Sparsing (SP): The sparsing parameter defines the interval between data points. For example:  
SP = 0 sends all data points  
SP = 1 sends all data points  
SP = 4 sends every 4th data point

Number of points (NP): The number of points parameter indicates how many points should be transmitted. For example:  
NP = 0 sends all data points  
NP = 1 sends 1 data point  
NP = 50 sends a maximum of 50 data points  
NP = 1001 sends a maximum of 1001 data points

First point (FP): The first point parameter specifies the address of the first data point to be sent. For waveforms acquired in sequence mode, this refers to the relative address in the given segment. For example:  
FP = 0 corresponds to the first data point  
FP = 1 corresponds to the second data point  
FP = 5000 corresponds to data point 5001

The WAVEFORM\_SETUP? query returns the transfer parameters currently in use.

**COMMAND SYNTAX**

Usage1:

WaveForm\_SetUp

SP,<sparsing>,NP,<number>, FP, <point>



Usage2:

WaveForm\_SetUp TYPE,<len>

<len>: = {0, 1}

**Note:**

- 1.For SPO models, you can use the usage2 to control the returned waveform data, 0 means all waveform data of screen, 1 means all waveform data of memory depth.

### QUERY SYNTAX

WaveForm\_SetUp?

**Note:**

- 1.Parameters are grouped in pairs. The first of the pair names the variable to be modified, whilst the second gives the new value to be assigned. Pairs may be given in any order and may be restricted to those variables to be changed.
- 2.After power-on ,SP is set to 4,NP is set to 100,and FP is set to 0.

### RESPONSE FORMAT

WaveForm\_SetUp

SP,<sparsing>,NP,<number>,FP,<point>

### EXAMPLE

The following command specifies that every 3rd data point (SP=3) starting at address 200 should be transferred:

Command message:

WFSU SP, 3, FP, 200

### RELATED COMMANDS

WAVEFORM

### **ACQUISITION**

### **WAIT, WAIT**

Command

#### **DESCRIPTION**

The WAIT command prevents the instrument from analyzing new commands until the oscilloscope has completed the current acquisition.

The instrument will be waiting for trigger or the limit time over (if we set it) or the device time out when we sent this command

#### **COMMAND SYNTAX**

WAIT <time>

#### **Note :**

This command can be used in two ways. One sets the limited time, another one doesn't set the limited time.

#### **EXAMPLE**

If we move the trigger level of the source to the position where the trace isn't triggered. Then we send an ARM command to set the trigger mode to single. Finally we send the WAIT command. The instrument will be waiting for triggering until the time over (if we set it) or time out.

If we move the trigger level of the source, and the instrument is triggered. Then we send an ARM command to set the trigger mode to single. Finally we send the WAIT command. The WAIT command will be finished if we send a FRTR for triggering.

Command message:

WAIT

**DISPLAY**

**XY\_DISPLAY, XYDS**

Command /Query

**DESCRIPTION**

The XY\_DISPLAY command enables or disables the display the XY format

The response to the XY\_DISPLAY? query indicates whether the XY format display is enabled.

**COMMAND SYNTAX**

XY\_DISPLAY <state>  
<state>: = {ON, OFF}

**QUERY SYNTAX**

XY\_DISPLAY?

**RESPONSE FORMAT**

XY\_DISPLAY <state>

**EXAMPLE**

The following command enables to display the XY format:

Command message:  
XYDS

## Programming Examples

This chapter give some examples for the programmer. In these examples you can see how to use the NI-VISA lib and the commands which have been described before this chapter to control our devices. By the examples' guide, you can develop more functions application as you want. This example is developed by Visual Studio project.

- Example of VC++
- Example of VB
- Example of MATLAB
- Example of LabVIEW
- Example of C#

## Example of VC++

Environment: Win7 32bit system, Visual Studio

The functions of this example: use the NI-VISA, to control the device with USBTMC or TCP/IP access to do a write and read.

Follow the steps to finish the example:

- 1、 Open Visual Studio, create a new VC++ win32 project.
- 2、 Set the project environment to use the NI-VISA lib, there are two ways to use NI-VISA, static or automatic:
  - 2.1 Static: find files: visa.h, visatype.h, visa32.lib in NI-VISA install path. Copy them to your project, and add them into project. In the projectname.cpp file, add the follow two lines:

```
#include "visa.h"
```

```
#pragma comment(lib, "visa32.lib")
```

2.2 Automatic:

Set the .h file include directory, the NI-VISA install path, in our computer we set the path is : C:\Program Files\IVI Foundation \VISA\WinNT\include. Set this path to project---properties---c/c++---General---Additional Include Directories: See the picture.

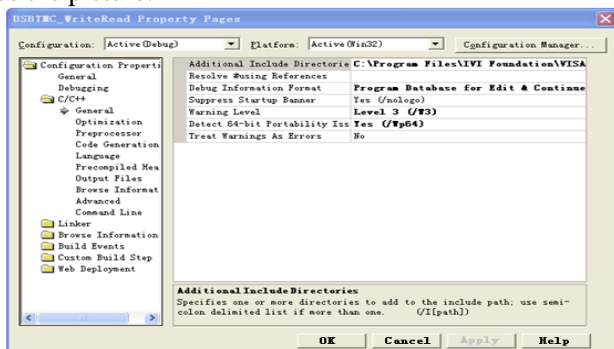

Set lib path set lib file:

Set lib path: the NI-VISA install path, in our computer we set the path is : C:\Program Files\IVI Foundation\VISA\WinNT\lib\msc. Set this path to project---properties---Linker---General---Additional Library Directories: as seen in the pictures below.

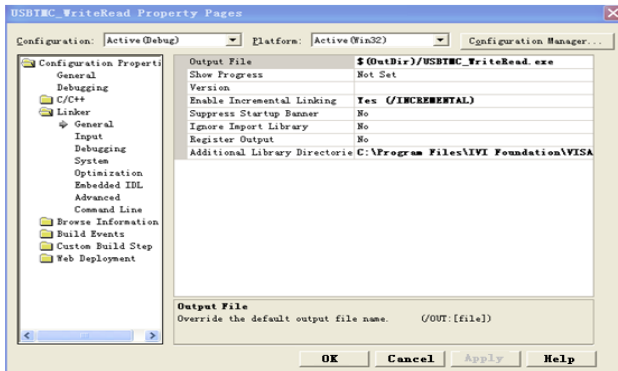

Set lib file:project---properties---Linker---Command Line---Additional Options: visa32.lib

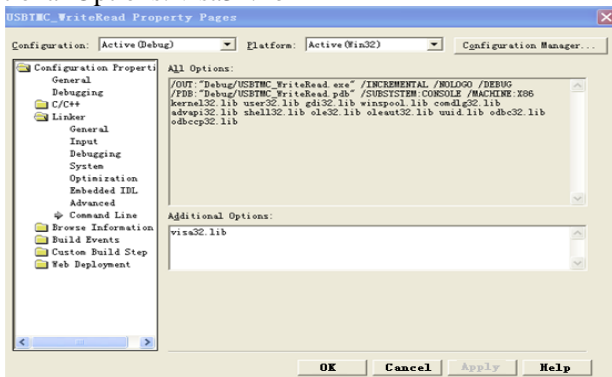

Include visa.h file: In the projectname.cpp file:

```
#include <visa.h>
```

3、 Add codes:

3.1 USBTMC access code:

Write a function Usbtmc\_test.

```
intUsbtmc_test()
{
/* This code demonstrates sending synchronous read & write
commands */
/* to an USB Test & Measurement Class (USBTMC) instrument
using */
/* NI-VISA */
/* The example writes the "**IDN?\n" string to all the USBTMC */
/* devices connected to the system and attempts to read back */
/* results using the write and read functions. */
/* The general flow of the code is */
/* Open Resource Manager */
/* Open VISA Session to an Instrument */
/* Write the Identification Query Using viPrintf */
/* Try to Read a Response With viScanf */
/* Close the VISA Session */
/*****/
ViSessiondefaultRM;
```

```
ViSessioninstr;
ViUInt32numInstrs;
ViFindListfindList;
ViUInt32retCount;
ViUInt32writeCount;
ViStatusstatus;
CharinstrResourceString[VI_FIND_BUFLEN];
Unsignedcharbuffer[100];
Charstringinput[512];
Inti;
/** First we must call viOpenDefaultRM to get the manager
 * handle. We will store this handle in defaultRM.*/
status=viOpenDefaultRM (&defaultRM);
if (status<VI_SUCCESS)
{
printf ("Could not open a session to the VISA Resource
Manager!\n");
returnstatus;
}
/* Find all the USB TMC VISA resources in our system and store the
number of resources in the system in numInstrs.          */
```



```
status = viFindRsrc (defaultRM, "USB?*INSTR", &findList,
&numInstrs, instrResourceString);

if (status<VI_SUCCESS)

{

printf ("An error occurred while finding resources.\nHit enter to
continue.");

fflush(stdin);

getchar();

viClose (defaultRM);

returnstatus;

}

/** Now we will open VISA sessions to all USB TMC instruments.
* We must use the handle from viOpenDefaultRM and we must
* also use a string that indicates which instrument to open. This
* is called the instrument descriptor. The format for this string
* can be found in the function panel by right clicking on the
* descriptor parameter. After opening a session to the
* device, we will get a handle to the instrument which we
* will use in later VISA functions. The AccessMode and Timeout
* parameters in this function are reserved for future
* functionality. These two parameters are given the value
VI_NULL.*/
```

```
for (i=0; i<numInstrs; i++)
{
if (i> 0)
viFindNext (findList, instrResourceString);
status = viOpen (defaultRM, instrResourceString, VI_NULL,
VI_NULL, &instr);
if (status<VI_SUCCESS)
{
printf ("Cannot open a session to the device %d.\n", i+1);
continue;
}
/* * At this point we now have a session open to the USB TMC
instrument.
* We will now use the viPrintf function to send the device the string
"*IDN?\n",
* asking for the device's identification. */
char * cmmmand ="*IDN?\n";
status = viPrintf (instr, cmmmand);
if (status<VI_SUCCESS)
{
printf ("Error writing to the device %d.\n", i+1);
status = viClose (instr);
```

```
continue;
}
/** Now we will attempt to read back a response from the device to
 * the identification query that was sent. We will use the viScanf
 * function to acquire the data.
 * After the data has been read the response is displayed.*/
status = viScanf(instr, "%t", buffer);
if (status<VI_SUCCESS)
printf ("Error reading a response from the device %d.\n", i+1);
else
printf ("\nDevice %d: %s\n", i+1,retCount, buffer);
status = viClose (instr);
}
/** Now we will close the session to the instrument using
 * viClose. This operation frees all system resources. */
status = viClose (defaultRM);
return 0;
}
```

### 3.2 TCP/IP access code:

Write a function TCP\_IP\_Test.

```
IntTCP_IP_Test(char *pIP)
```

---

```
{  
CharoutputBuffer[VI_FIND_BUFLEN];  
ViSessiondefaultRM, instr;  
ViStatusstatus;  
ViUInt32count;  
ViUInt16portNo;  
  
/* First we will need to open the default resource manager. */  
status = viOpenDefaultRM (&defaultRM);  
if (status<VI_SUCCESS)  
{  
printf("Could not open a session to the VISA Resource Manager!\n");  
}  
  
/* Now we will open a session via TCP/IP device */  
Charhead[256] ="TCPIP0:";  
Chartail[] = "::INSTR";  
Charresource [256];  
strcat(head,pIP);  
strcat(head,tail);  
status = viOpen (defaultRM, head, VI_LOAD_CONFIG, VI_NULL,  
&instr);  
if (status<VI_SUCCESS)  
{
```

```
printf ("An error occurred opening the session\n");
viClose(defaultRM);
}
status = viPrintf(instr, "*idn?\n");
status = viScanf(instr, "%t", outputBuffer);
if (status<VI_SUCCESS)
{
printf("viRead failed with error code: %x \n",status);
viClose(defaultRM);
}else
printf ("\ndata read from device: %*s\n", 0,outputBuffer);
status = viClose (instr);
status = viClose (defaultRM);
return 0;
}
```

## Example of VB

Environment: Win7 32bit system, Microsoft Visual Basic 6.0

The function of this example: Use the NI-VISA, to control the device with USBTMC and TCP/IP access to do a write and read.

Follow the steps to complete the example:

- 1、 Open Visual Basic, build a standard application program project (Standard EXE)
- 2、 Set the project environment to use the NI-VISA lib, Click the Existing tab of Project>>Add Module. Search for the visa32.bas file in the include folder under the NI-VISA installation path and add the file.

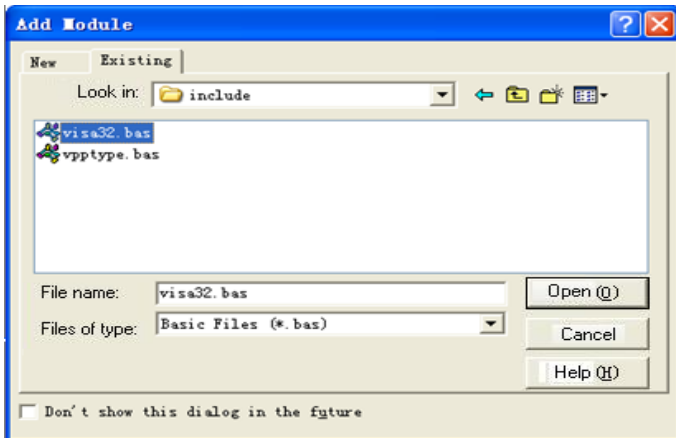

This allows the VISA functions and VISA data types to be used in a program.

- 3、 Add codes:

### 3.1、 USBTMC access code:

Write a function Usbtmc\_test.

Private Function Usbtmc\_test() As Long

' This code demonstrates sending synchronous read & write commands

' to an USB Test & Measurement Class (USBTMC) instrument using

' NI-VISA

' The example writes the "\*IDN?\n" string to all the USBTMC

' devices connected to the system and attempts to read back

' results using the write and read functions.

' The general flow of the code is

' Open Resource Manager

' Open VISA Session to an Instrument

' Write the Identification Query Using viWrite

' Try to Read a Response With viRead

' Close the VISA Session

Const MAX\_CNT = 200

Dim defaultRM As Long

Dim instrsesn As Long

Dim numInstrs As Long

Dim findList As Long

Dim retCount As Long

Dim writeCount As Long

Dim status As Long

Dim instrResourceString As String \* VI\_FIND\_BUFLEN

Dim buffer As String \* MAX\_CNT

Dim i As Integer

' First we must call viOpenDefaultRM to get the manager

' handle. We will store this handle in defaultRM.

status = viOpenDefaultRM(defaultRM)

If (status < VI\_SUCCESS) Then

    Debug.Print "Could not open a session to the VISA Resource  
Manager!"

    Usbtmc\_test = status

ExitFunction

End If

' Find all the USB TMC VISA resources in our system and store  
the

' number of resources in the system in numInstrs.



```
status = viFindRsrc(defaultRM, "USB?*INSTR", findList, numInstrs,  
instrResourceString)
```

```
If (status < VI_SUCCESS) Then
```

```
    Debug.Print "An error occurred while finding resources."
```

```
    viClose (defaultRM)
```

```
    Usbtmc_test = status
```

```
Exit Function
```

```
End If
```

' Now we will open VISA sessions to all USB TMC instruments.

' We must use the handle from viOpenDefaultRM and we must

' also use a string that indicates which instrument to open. This

' is called the instrument descriptor. The format for this string

' can be found in the function panel by right clicking on the

' descriptor parameter. After opening a session to the

' device, we will get a handle to the instrument which we

' will use in later VISA functions. The AccessMode and Timeout

' parameters in this function are reserved for future

' functionality. These two parameters are given the value

VI\_NULL.

```
For i = 0 To numInstrs
```

```
If (i > 0) Then
```

```
status = viFindNext(findList, instrResourceString)
```

```
End If
```

```
status = viOpen(defaultRM, instrResourceString, VI_NULL,  
VI_NULL, instrsesn)
```

```
If (status < VI_SUCCESS) Then
```

```
    Debug.Print "Cannot open a session to the device ", i + 1
```

```
    GoTo NextFind
```

```
End If
```

```
' At this point we now have a session open to the USB TMC  
instrument.
```

```
' We will now use the viWrite function to send the device the  
string "*IDN?",
```

```
' asking for the device's identification.
```

```
status = viWrite(instrsesn, "*IDN?", 5, retCount)
```

```
If (status < VI_SUCCESS) Then
```

```
    Debug.Print "Error writing to the device."
```

```
    status = viClose(instrsesn)
```

```
    GoTo NextFind
```

```
End If
```

```
' Now we will attempt to read back a response from the device  
to
```

' the identification query that was sent. We will use the viRead  
' function to acquire the data.

' After the data has been read the response is displayed.

```
status = viRead(instrsesn, buffer, MAX_CNT, retCount)
```

```
If (status < VI_SUCCESS) Then
```

```
    Debug.Print "Error reading a response from the device.", i +
```

```
    1
```

```
Else
```

```
    Debug.Print i + 1, retCount, buffer
```

```
End If
```

```
status = viClose(instrsesn)
```

```
NextFind:
```

```
Next i
```

' Now we will close the session to the instrument using

' viClose. This operation frees all system resources.

```
status = viClose(defaultRM)
```

```
Usbtmc_test = 0
```

```
End Function
```

3.2、TCP/IP access code:

Write a function TCP\_IP\_Test.

Private Function TCP\_IP\_Test(ip As String) As Long

Dim outputBuffer As String \* VI\_FIND\_BUFLLEN

Dim defaultRM As Long

Dim instrsesn As Long

Dim status As Long

Dim count As Long

' First we will need to open the default resource manager.

status = viOpenDefaultRM (defaultRM)

If (status < VI\_SUCCESS) Then

    Debug.Print "Could not open a session to the VISA Resource Manager!"

    TCP\_IP\_Test = status

    Exit Function

End If

' Now we will open a session via TCP/IP device

status = viOpen(defaultRM, "TCPIP0::" + ip + "::INSTR",  
VI\_LOAD\_CONFIG, VI\_NULL, instrsesn)

If (status < VI\_SUCCESS) Then

    Debug.Print "An error occurred opening the session"

    viClose (defaultRM)

```
TCP_IP_Test = status
```

```
Exit Function
```

```
End If
```

```
status = viWrite(instrsesn, "**IDN?", 5, count)
```

```
If (status < VI_SUCCESS) Then
```

```
    Debug.Print "Error writing to the device."
```

```
End If
```

```
status = viRead(instrsesn, outputBuffer, VI_FIND_BUFLen, count)
```

```
If (status < VI_SUCCESS) Then
```

```
    Debug.Print "Error reading a response from the device.", i + 1
```

```
Else
```

```
    Debug.Print "read from device:", outputBuffer
```

```
End If
```

```
status = viClose(instrsesn)
```

```
status = viClose(defaultRM)
```

```
TCP_IP_Test = 0
```

```
End Function
```

## Example of MATLAB

Environment: Win7 32bit system, MATLAB R2010b

The function of this example: Use the NI-VISA, to control the device with USBTMC or TCP/IP access to do a write and read.

Follow the steps to complete the example:

Open MATLAB, modify the current directory. In this demo, the current directory is modified to D:\USBTMC\_TCPIP\_Demo.

Click File>>New>>Script in the Matlab interface to create an empty M file

Add codes:

USBTMC access code:

Write a function Usbtmc\_test.

```
function USBTMC_test()
% This code demonstrates sending synchronous read & write
% commands
% to an USB Test & Measurement Class (USBTMC) instrument using
% NI-VISA

%Create a VISA-USB object connected to a USB instrument
vu = visa('ni','USB0::0xF4EC::0xEE38::0123456789::INSTR');

%Open the VISA object created
fopen(vu);

%Send the string "*IDN?",asking for the device's identification.
fprintf(vu,'*IDN?');
```

**%Request the data**

```
outputbuffer = fscanf(vu);  
disp(outputbuffer);
```

**%Close the VISA object**

```
fclose(vu);  
delete(vu);  
clear vu;
```

**end**

3.2 TCP/IP access code:

Write a function TCP\_IP\_Test.

```
function TCP_IP_test( IPstr )
```

**% This code demonstrates sending synchronous read & write commands**

**% to an TCP/IP instrument using NI-VISA**

**%Create a VISA-TCPIP object connected to an instrument**

**%configured with IP address.**

```
vt = visa('ni',['TCPIP0::',IPstr, '::INSTR']);
```

**%Open the VISA object created**

```
fopen(vt);
```

**%Send the string "\*IDN?",asking for the device's identification.**

```
fprintf(vt, '*IDN?');
```

**%Request the data**

```
outputbuffer = fscanf(vt);
```

```
disp(outputbuffer);
```

```
%Close the VISA object
```

```
fclose(vt);
```

```
delete(vt);
```

```
clear vt;
```

```
end
```

## Example of LabVIEW

Environment: Win7 32bit system, LabVIEW 2011



The functions of this example: use the NI-VISA, to control the device with USBTMC and TCP/IP access to do a write and read.

Follow the steps to complete the example:

- 1、 Open LabVIEW, create a VI file.
- 2、 Add controls. Right-click in the **Front Panel** interface, select and add **VISA resource name**, error in, error out and some indicators from the Controls column.
- 3、 Open the **Block Diagram** interface. Right-click on the **VISA resource name** and you can select and add the following functions from VISA Palette from the pop-up menu: **VISA Write**, **VISA Read**, **VISA Open** and **VISA Close**.
- 4、 Connect them as shown in the figure below

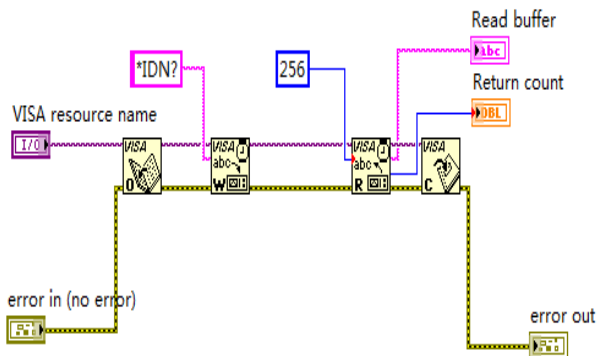

- 5、 Select the device resource from the VISA Resource Name list box and run the program.

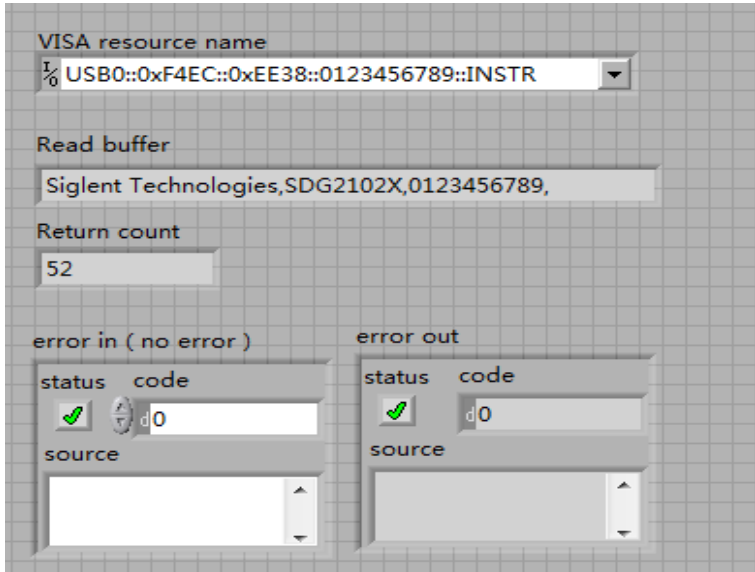

In this example, the VI opens a VISA session to a USBTMC device, writes a command to the device, and reads back the response. In this example, the specific command being sent is the device ID query. Check with your device manufacturer for the device command set. After all communication is complete, the VI closes the VISA session.

6、 Communicating with the device via TCP/IP is similar to USBTMC. But you need to change VISA Write and VISA Read Function to Synchronous I/O. The LabVIEW default is asynchronous I/O. Right-click the node and select Synchronous I/O Mod>>Synchronous from the shortcut menu to write or read data synchronously.

7、 Connect them as shown in the figure below

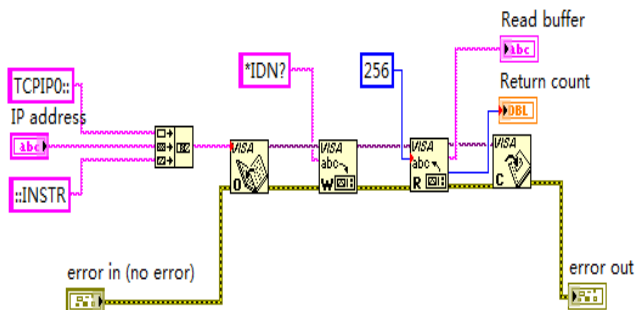

8、 Input the IP address and run the program.

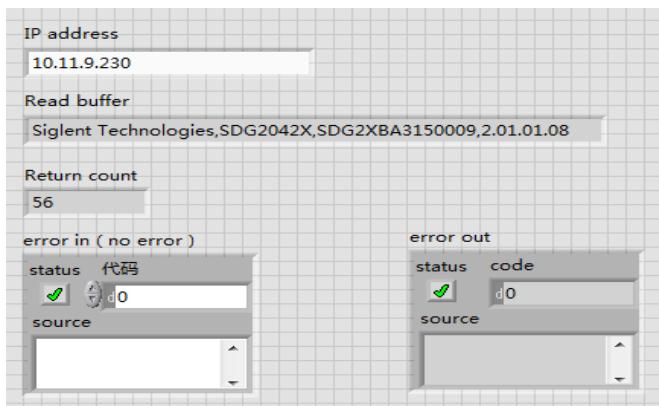

## Example of C#

Environment: Win7 32bit system, Visual Studio

The functions of this example: use the NI-VISA, to control the device with USBTMC or TCP/IP access to do a write and read.

Follow the steps to finish the example:

- 1、 Open Visual Studio, create a new C# project.
- 2、 Add References. Add NationalInstruments.Common.dll and NationalInstruments.VisaNS.dll to the project. (Notice: you must install the .NET Framework 3.5/4.0/4.5 Languages support when you install the NI-VISA.)

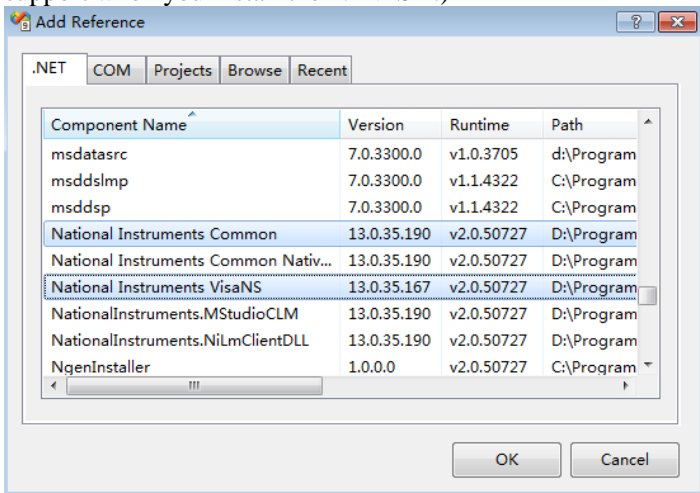

- 3、 Write C# Code

```
using System;
using System.Collections.Generic;
using System.Linq;
using System.Text;
```

```
using NationalInstruments.VisaNS;

namespace TestVisa
{
    class Program
    {
        static void Main(string[] args)
        {
            // Find all the USBTMC resources
            string[] usbRsrcStrings =
ResourceManager.GetLocalManager().FindResources("USB?*INSTR");
            if (usbRsrcStrings.Length <= 0)
            {
                Console.WriteLine("Can not find USBTMC Device!");
                return;
            }

            //Choose the first resource string to connect the
device.

            //You can input the address manually
            //USBTMC:
            //MessageBasedSession mbSession =
(MessageBasedSession)ResourceManager.GetLocalManager().Open("USB
0::0xF4EC::0xEE38::0123456789::INSTR");
            //TCP IP:
            //MessageBasedSession mbSession =
(MessageBasedSession)ResourceManager.GetLocalManager().Open("TCP
IP0::192.168.1.100::INSTR");
            MessageBasedSession mbSession =
(MessageBasedSession)ResourceManager.GetLocalManager().Open(usbR
srcStrings[0]);
            mbSession.Write(" *IDN?");
            string result = mbSession.ReadString();
            mbSession.Dispose();
        }
    }
}
```

---

```
        Console.WriteLine(result);  
    }  
}  
}
```

---

# Index

## A

ALL\_STATUS?, ALST?, Query,  
ARM\_ACQUISITION, ARM, Command,  
ATTENUATION, ATTN, Command/Query,  
AUTO\_CALIBRATE, ACAL, Command/Query,  
AUTO\_SETUP, ASET, Command,  
AUTO\_TYPESET, AUTTS, Command/Query,  
AVERAGE\_ACQUIRE, AVGA, Command/Query,

## B

BANDWIDTH\_LIMIT, BWL, Command/Query,  
BUZZER, BUZZ, Command,

## C

CAL?, Query,  
CLS, Command,  
CMR?, Query,  
COMM\_NET, CONET, Command/Query,  
COUPLING, CPL, Command/Query,  
CURSOR\_SET, CRST, Command/Query,  
CURSOR\_VALUE?, CRVA?, Query,  
CURSOR\_AUTO, CRAU, Command,  
CSV\_SAVE, CSVS, Command/Query,  
COUNTER, COUN, Command/Query,  
CYMOMETER, CYMT, Query,

## D

DATE, Command/Query,  
DDR?, Query,  
DEFINE, DEF, Command/Query,  
DELETE\_FILE, DELF, Command,  
DIRECTORY, DIR, Command/Query,  
DOT\_JOIN, DTJN, Command/Query,

## E

ESE, Command/Query,  
ESR?, Query,  
EXR?, Query,

### F

FILENAME, FLNM, Command/Query,  
FORMAT\_VDISK, FVDISK, Query,  
FILTER, FILT, Command/Query,  
FILT\_SET, FILTS, Command/Query,  
FFT\_WINDOW, FFTW, Command/Query,  
FFT\_ZOOM, FFTZ, Command/Query,  
FFT\_SCALE, FFTS, Command/Query,  
FFT\_FULLSCREEN, FFTF, Command/Query,

### G

GRID\_DISPLAY, GRDS, Command/Query,  
GCSV, GET\_CSV, Query,

### H

HARDCOPY\_SETUP, HCSU,  
HOR\_MAGNIFY, HMAG, Command/Query,  
HOR\_POSITION, HPOS, Command/Query,

### I

IDN?, Query,  
INTENSITY, INTS, Command/Query,  
INTERLEAVED, ILVD, Command/Query,  
INR, INR, Query,  
INVERT\_SET, INVS, Command/Query,

### L

LOCK, Command/Query,

### M

MENU, MENU, Command/Query,  
MATH\_VERT\_POS, MTVP, Command/Query,  
MATH\_VERT\_DIV, MTVD, Command/Query,  
MEASURE\_DELY, MEAD, Command/Query,

### O

OFFSET, OFST, Command/Query,  
OPC, Command/Query,

### P

PARAMETER\_CLR, PACL, Command,  
PARAMETER\_CUSTOM, PACU, Command/Query,  
PARAMETER\_VALUE?, PAVA?, Query,



PEAK\_DETECT, PDET, Command/Query,  
PERSIST, PERS, Command/Query,  
PERSIST\_SETUP, PESU, Command/Query,  
PANEL\_SETUP, PNSU, Command/Query,  
PF\_DISPLAY, PFDS, Command/Query,  
PF\_SET, PFST, Command/Query,  
PF\_SAVELOAD, PFSL, Command,  
PF\_CONTROL, PFCT, Command/Query,  
PF\_CREATEM, PFCM, Command,  
PF\_DATEDIS, PFDD, Query,

### R

RCL, Command,  
RECALL, REC, Command,  
RECALL\_PANEL, RCPN, Command,  
RST, Command,  
REF\_SET, REFS, Command/Query,

### S

SAV, Command,  
SCREEN\_DUMP, SCDP, Command/Query,  
SRE, Command/Query,  
STB? Query,  
STOP, Command,  
STORE, STO, Command,  
STORE\_PANEL, STPN, Command,  
STORE\_SETUP, STST, Command/Query,  
SAMPLE\_STATUS, SAST/ Query,  
SAMPLE\_RATE, SARA/ Query,  
SAMPLE\_NUM, SANU/ Query,  
SKEW, SKEW, Command,  
SETTO%50, SET50, Command,  
SINXX\_SAMPLE, SXSA, Command/Query,

### T

TIME\_DIV, TDIV, Command/Query,  
TRACE, TRA, Command/Query,  
TRG, Command,  
TRIG\_COUPLING, TRCP, Command/Query,  
TRIG\_DELAY, TRDL, Command/Query,  
TRIG\_LEVEL, TRLV, Command/Query,  
TRIG\_MODE, TRMD, Command/Query,  
TRIG\_SELECT, TRSE, Command/Query,  
TRIG\_SLOPE, TRSL, Command/Query,

### U

UNIT, UNIT, Command/Query,

### V

VOLT\_DIV, VDIV, Command/Query,

VERTICAL, VTCL, Command/Query,

### W

WAIT, Command,

WAVEFORM, WF, Command/Query,

WAVEFORM\_SETUP, WFSU, Command/Query,

### X

XY\_DISPLAY, XYDS, Command/Query,